



# SOLAR PUMPS

Submersible Pumps & Motors  
Monoblock Pumps



May/2016-17/L/71000 VC : 2344 SAP No. 2900000726



India : Toll Free No. 1800 103 5555 Other Countries : +91-7292 410500

## SHAKTI PUMPS (I) LTD.

Sector - 3, Pithampur - 454774, Dist. - Dhar, (M.P.) - INDIA  
Fax: +91-7292 410519, E-mail: info@shaktipumps.com, sales@shaktipumps.com,  
Visit us at : www.shaktipumps.com

## CONTENT

	PAGE NO.		PAGE NO.
INTRODUCTION OF SOLAR PUMPING SYSTEM.....	01-03	SSP10000 - 20 - 57, 10 HP.....	54
SOLAR CONTROLLER.....	04-06	SSP10000 - 40 - 31, 10 HP.....	55
<b>SOLAR SUBMERSIBLE PUMP</b>		SSP9000 - 50 - 21, 10 HP.....	56
<b>SSP SERIES</b>		SSP10000 - 80 - 14, 10 HP.....	57
SSP500 - 20 - 26, 0.5 HP.....	08	SSP10000 - 140 - 9, 10 HP.....	58
SSP750 - 20 - 32, 1 HP.....	09	SSP12500 - 30 - 41, 12.5 HP.....	59
SSP750 - 30 - 18, 1 HP.....	10	SSP15000 - 60 - 22, 15 HP.....	60
SSP900 - 50 - 13, 1 HP.....	11	SSP15000 - 100 - 13, 15 HP.....	61
SSP1000 - 10 - 102, 1 HP.....	12	SSP20000 - 80 - 16, 20 HP.....	62
SSP1000 - 30 - 29, 1 HP.....	13	SSP20000 - 120 - 11, 20 HP.....	63
SSP1000 - 70 - 7, 1 HP.....	14		
SSP1200 - 20 - 44, 1 HP.....	15	<b>SOLAR MONOBLOCK PUMP</b>	
SSP1200 - 35 - 26, 1 HP.....	16	<b>SMP SERIES</b>	
SSP1200 - 40 - 19, 1 HP.....	17	SMP1200 - 20 - 30, 1.0 HP.....	65
SSP1200 - 70 - 10, 1 HP.....	18	SMP2000 - 20 - 56, 2.0 HP.....	66
SSP1200 - 90 - 6, 1 HP.....	19	SMP3000 - 20 - 60, 3.0 HP.....	67
SSP1500 - 25 - 36, 1.5 HP.....	20	SMP5000 - 30 - 36, 5.0 HP.....	68
SSP1500 - 40 - 22, 1.5 HP.....	21		
SSP1500 - 70 - 13, 1.5 HP.....	22		
SSP1500 - 90 - 8, 1.5 HP.....	23		
SSP2000 - 10 - 93, 2 HP.....	24		
SSP2000 - 20 - 52, 2 HP.....	25		
SSP2000 - 30 - 37, 2 HP.....	26		
SSP2000 - 40 - 23, 2 HP.....	27		
SSP2000 - 60 - 15, 2 HP.....	28		
SSP2000 - 80 - 10, 2 HP.....	29		
SSP2000 - 90 - 9, 2 HP.....	30		
SSP2000 - 120 - 6, 2 HP.....	31		
SSP2600 - 10 - 104, 3 HP.....	32		
SSP3000 - 10 - 120, 3 HP.....	33		
SSP3000 - 20 - 62, 3 HP.....	34		
SSP3000 - 25 - 44, 3 HP.....	35		
SSP3000 - 45 - 27, 3 HP.....	36		
SSP3000 - 50 - 19, 3 HP.....	37		
SSP3000 - 50 - 25, 3 HP.....	38		
SSP3000 - 70 - 15, 3 HP.....	39		
SSP3000 - 100 - 10, 3 HP.....	40		
SSP4000 - 30 - 45, 3 HP.....	41		
SSP4000 - 70 - 15, 4 HP.....	42		
SSP4000 - 120 - 8, 4 HP.....	43		
SSP5000 - 10 - 129, 5 HP.....	44		
SSP5000 - 20 - 64, 5 HP.....	45		
SSP5000 - 30 - 39, 5 HP.....	46		
SSP5000 - 50 - 24, 5 HP.....	47		
SSP5000 - 70 - 18, 5 HP.....	48		
SSP5000 - 100 - 11, 5 HP.....	49		
SSP5000 - 220 - 4, 5 HP.....	50		
SSP6750 - 70 - 18 / 50-21, 7.5 HP.....	51		
SSP7500 - 100 - 12, 7.5 HP.....	52		
SSP9000 - 130 - 10, 10 HP.....	53		

## INTRODUCTION OF SOLAR PUMPING SYSTEM

Solar pumping system becomes more and more popular, it can be applied to daily use (underground water), agriculture irrigation, forestry irrigation, desert control, pasture animal husbandry, water supply for islands, wastewater treatment engineering, and so on. In recent years, with the promotion of the utilization of new energy resources, solar pumping systems are more and more used in municipal engineering, city centre squares, parks, tourist sites, resorts and hotels, the landscapes and fountain systems in the residential areas. This system is composed of a solar array, a pump and a solar pumping inverter. Based on the design philosophy that it is better to store water than electricity, there is no energy storing device such as store battery in the system.

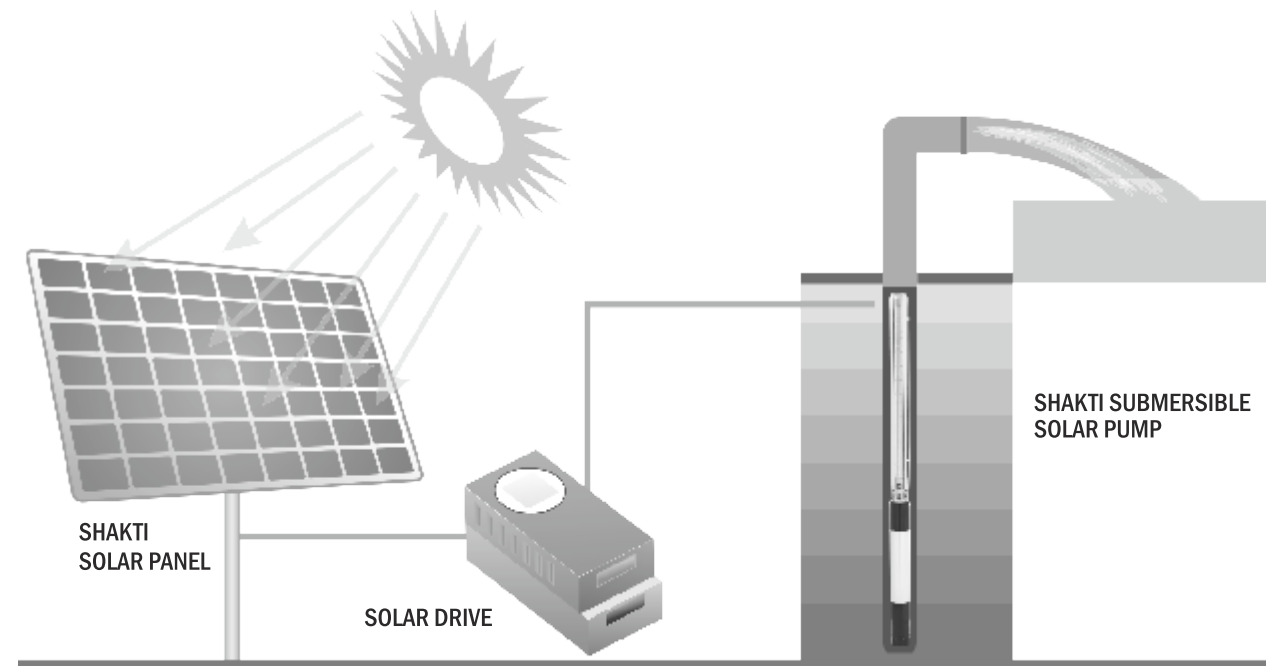

### Structure of solar pumping system

The solar array, an aggregation of many solar modules connected in series and parallel, absorbs sunlight radiation and converts it into electrical energy, providing dynamical water for the whole system. The pumping inverter controls and adjusts the system operation and converts the DC produced by solar array into AC to drive the pump, and adjust the output frequency in real-time according to the variation of sunlight intensity to realize the maximum power point tracking (MPPT). The pump, drive by 3-phase AC motor, can draw water from the deep wells or rivers and lakes to pour into the storage tank or reservoir, or directly connect to the irrigation system, fountain system, ect. According to the actual system demand and installation conditions, different types of pump such as centrifugal pump, axial flow pump, mixed-flow pump or deep-well pump can be used.

### Applications

- Ground water lowering
- Irrigation systems
- Industrial Application
- Drip irrigation & sprinkler
- Tank / Cistern filling
- Wildlife refuge
- Rural water supply for ranches, cabins, and cottages
- Fountains

### Features

- High flow system for faster tank fill and significant water output.
- Proven motor and pump technology for long-term reliability
- Available Free of cost at your doorstep.
- Clean and pollution free energy, Eco-friendly & do not harm nature.
- Ideal for remote areas, where electricity is not available or availability is capital intensive.
- Suitable for day time irrigation, Continuous supply for 6-8 hours in a day.
- MPPT – Max Power Point Tracking for maximizing efficiency of input power
- Soft start feature prevents water hammer and increases system life Easy to operate.
- Simple installation and no required maintenance.
- MNRE approved.

### All-in-One Package

The Solar drive PAK is the System Solution for solar pumping requirements. Using Shakti Electric's quality components, our technical expertise in groundwater pumping, and innovative thinking based on global market inputs, we have developed a rugged, high-output system which tackles the challenges of remote and harsh environments. No other system delivers the features, benefits, and reliability of Solar drive PAK in just one package!

### The Solar water pumping system includes

- Shakti Electric Submersible motor
- Shakti Submersible pump
- Solar Panel and its mounting structure
- Solar Drive controller
- Cable
- Pipes
- Variety of flow rates available in: 5 to 5000 lpm. (1.4 to 1320 US GPM)
- Motor and drive ratings available in: 1.0 to 100.0 HP (0.75 to 75.0 kW)

## INTRODUCTION OF SOLAR PUMPING SYSTEM

### SSP SERIES

Type designation

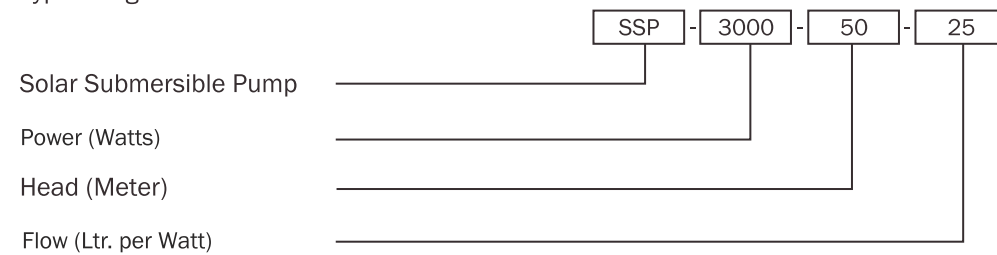

### SMP SERIES

Type designation

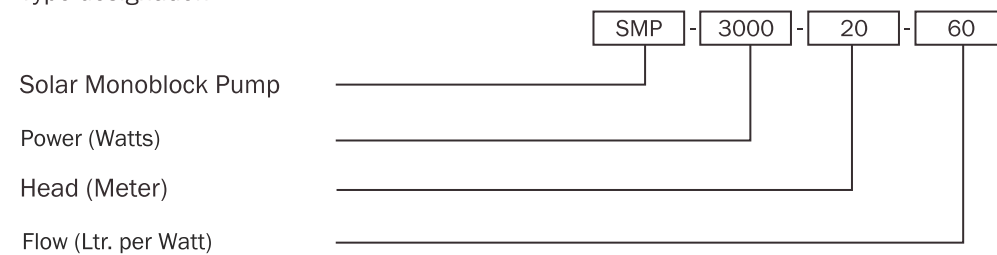

\*Note :- Input power at Motor end

## SOLAR CONTROLLER

### OVERVIEW

The Shakti Solar controller is a variable speed motor drive designed to run a Shakti three-phase AC motor. The Shakti Solar provides water to remote locations by converting high voltage, direct current from a solar array into alternating current to run a shakti AC motor. When solar power is not available, the controller can manual switch to an alternate three or single-phase AC input such as a grid or generator or inverter from battery, if available. The controller provides fault detection, motor soft start, and speed control.

The Shakti Solar drive is designed with the high standard of reliability expected of Shakti products. The controller attempts to drive the pump and motor to deliver water even under adverse conditions, reducing output as necessary to protect the system components from damage, and only shutting down in extreme cases.

### Descriptions and Features

The Shakti Solar drives controller continuously monitors system performance and incorporates a number of features for pump system protection. In the event of a fault, the Shakti Solar drives will indicate the type of fault through the LCD displays.

**The Shakti Solar drives system is optimized for pumping under adverse input power conditions unique to solar arrays.**

- Internal diagnostics will tolerate a lower input voltage.
- Whenever possible, the controller attempts to regulate the pump load in a manner that optimizes for maximum power transfer from the solar array.
- The drive manually switches to AC backup power (when available) if the DC primary source is unable to support pump operation.

**The controller construction is ruggedized for hostile environmental conditions.**

- The case is constructed of heavy-gauge zinc plated steel to resist rain, animal intrusion and prolonged direct exposure to sunlight.
- The seals are designed for NEMA 3 (IEC rating IP55), (dust tight, and withstand directed jets of water).
- For maximum protection against dust, there is no external cooling fan or other external moving parts.

**An easy to use interface is provided to enhance configurability and enable remote system monitoring.**

- A three-digit seven-segment display provides a detailed indication of system status.
- A small keypad offers flexibility for selection of user options.
- A continuous data connection for remote telemetry is made available via an RS-485 port. (Optional)
- If using remote telemetry, follow the register information found in the RS-485 addendum. (Optional)

### PROTECTION FEATURES

Electronic monitoring gives the controller the capability to monitor the system and automatically shut down in the event of: Dry run conditions – with smart pump monitoring, High Voltage Surge, Low Input Voltage, Open motor circuit, Short circuit, Over heat, Earth fault

## SOLAR CONTROLLER

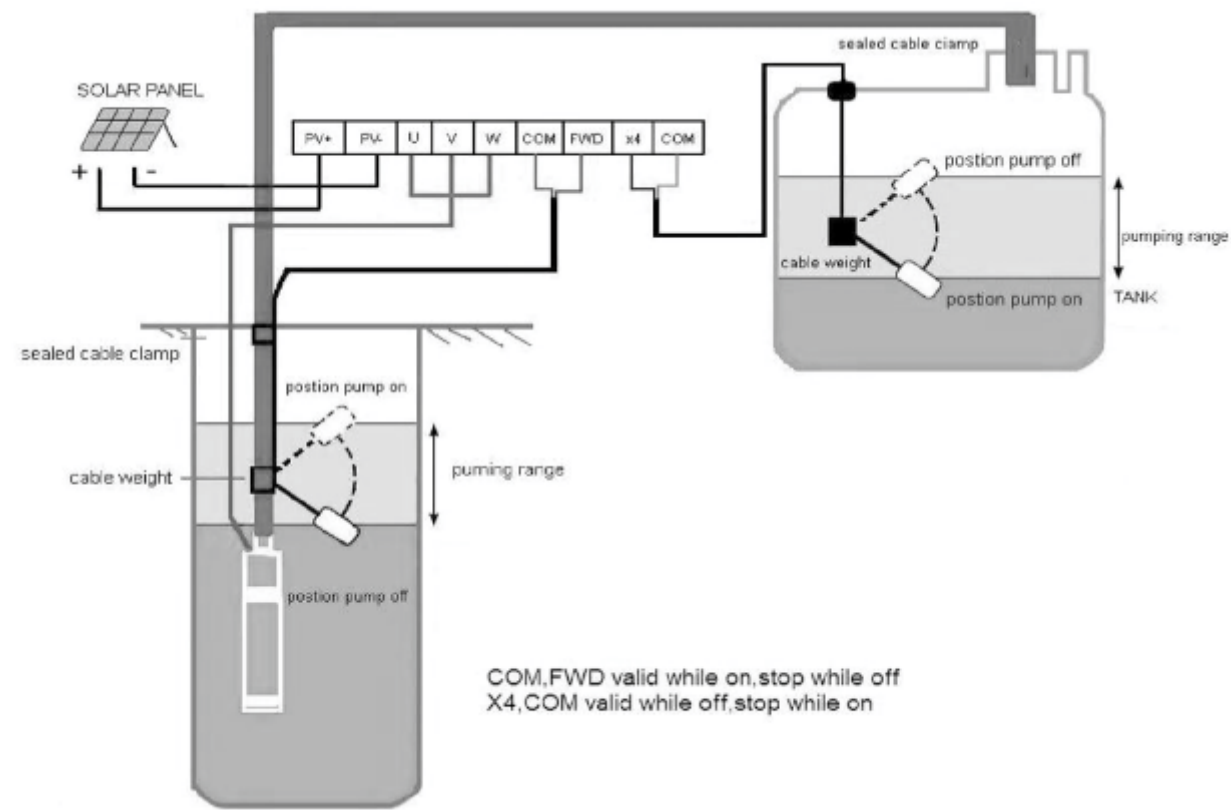

### SOLAR PUMP DRIVE SPECIFICATION

Model	Power of drive (kW)	Max. Input voltage of Solar Arrays (Vdc)	Range of MPPT (Vdc)	Rated Output Voltage (V)	Rated Output Current (A)	Output frequency (Hz)
SHAKTI-01P-10A	1.5	400	100-350	110-230	10	0-60
SHAKTI-01P-10A	2.2	450	150-400	150-230	10	0-60
SHAKTI-03P-13A	4	780	300-680	230-460	13	0-60
SHAKTI-03P-17A	7.5	780	300-680	230-460	17	0-60
SHAKTI-03P-25A	9	780	300-680	230-460	25	0-60
SHAKTI-03P-32A	11	780	300-680	230-460	32	0-60
SHAKTI-03P-38A	15	780	300-680	230-460	38	0-60
SHAKTI-03P-45A	18	780	300-680	230-460	45	0-60
SHAKTI-03P-60A	22	780	300-680	230-460	60	0-60

## SOLAR CONTROLLER

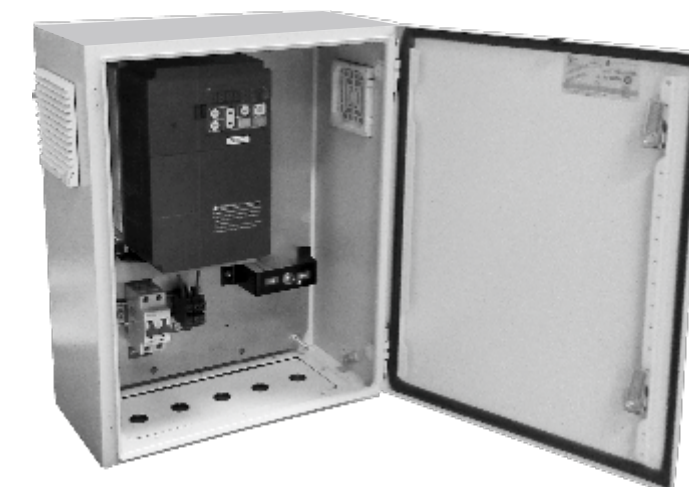

**SOLAR SUBMERSIBLE PUMP**

**SSP SERIES**



**PUMP PERFORMANCE SSP500 - 20 - 26**

**MOTOR 0.5 HP**

110 Volt Motor – (4"x4") – BSP 1.25"  
 Maximum OD 4" – Material Code 9500000085

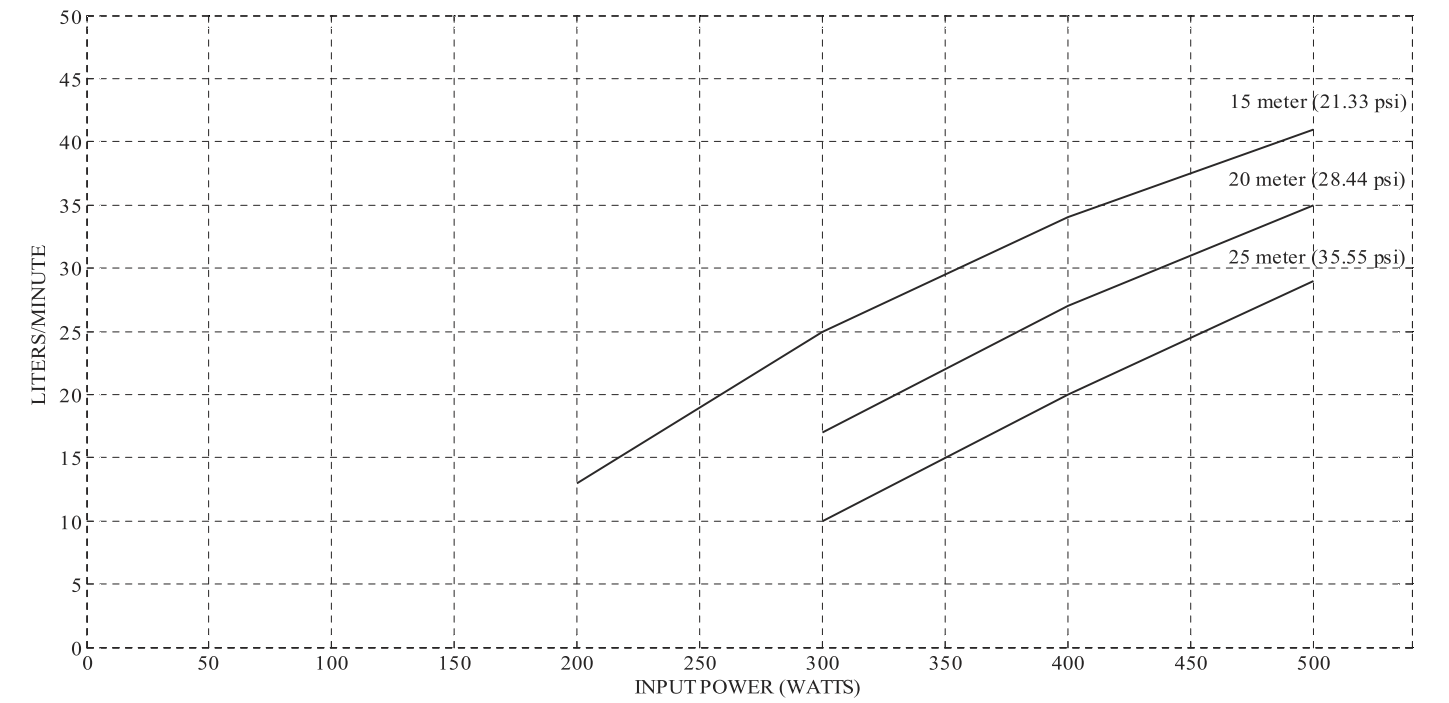

	INPUT POWER (WATTS)			
	500	400	300	200
HEAD (M)	FLOW RATE (LITERS / MINUTE)			
15	41	34	25	13
20	35	27	17	
25	29	20	10	

**PUMP PERFORMANCE SSP750 - 20 - 32**

**MOTOR 1 HP**

110 Volt Motor – (4"x4") – BSP 1.25"  
Maximum OD 4" – Material Code 9500000020

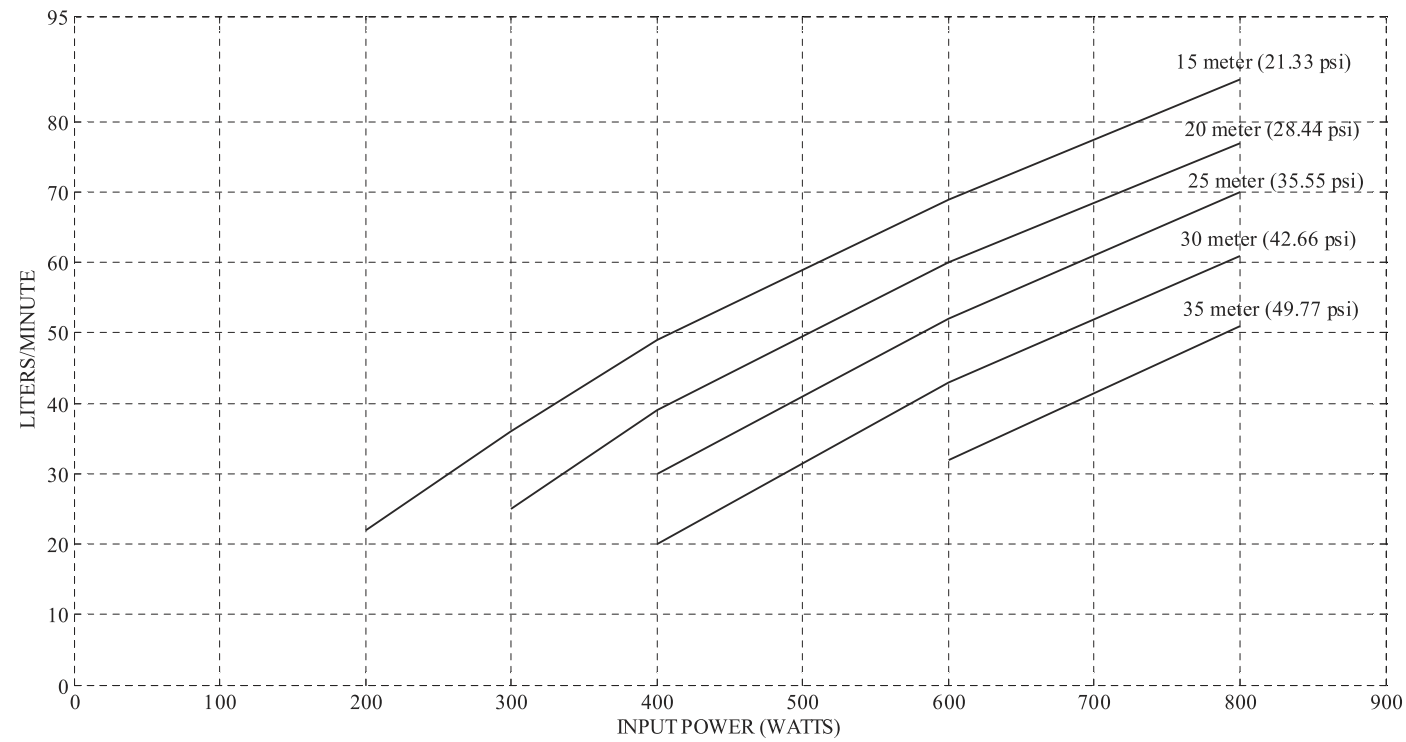

	INPUT POWER (WATTS)				
	800	600	400	300	200
HEAD (M)	FLOW RATE (LITERS / MINUTE)				
15	86	69	49	36	22
20	77	60	39	25	
25	70	52	30		
30	61	43	20		
35	51	32			



**PUMP PERFORMANCE SSP750 - 30 - 18**

**MOTOR 1 HP**

110 Volt Motor – (4"x4") – BSP 1.25"  
Maximum OD 4" – Material Code 9500000015

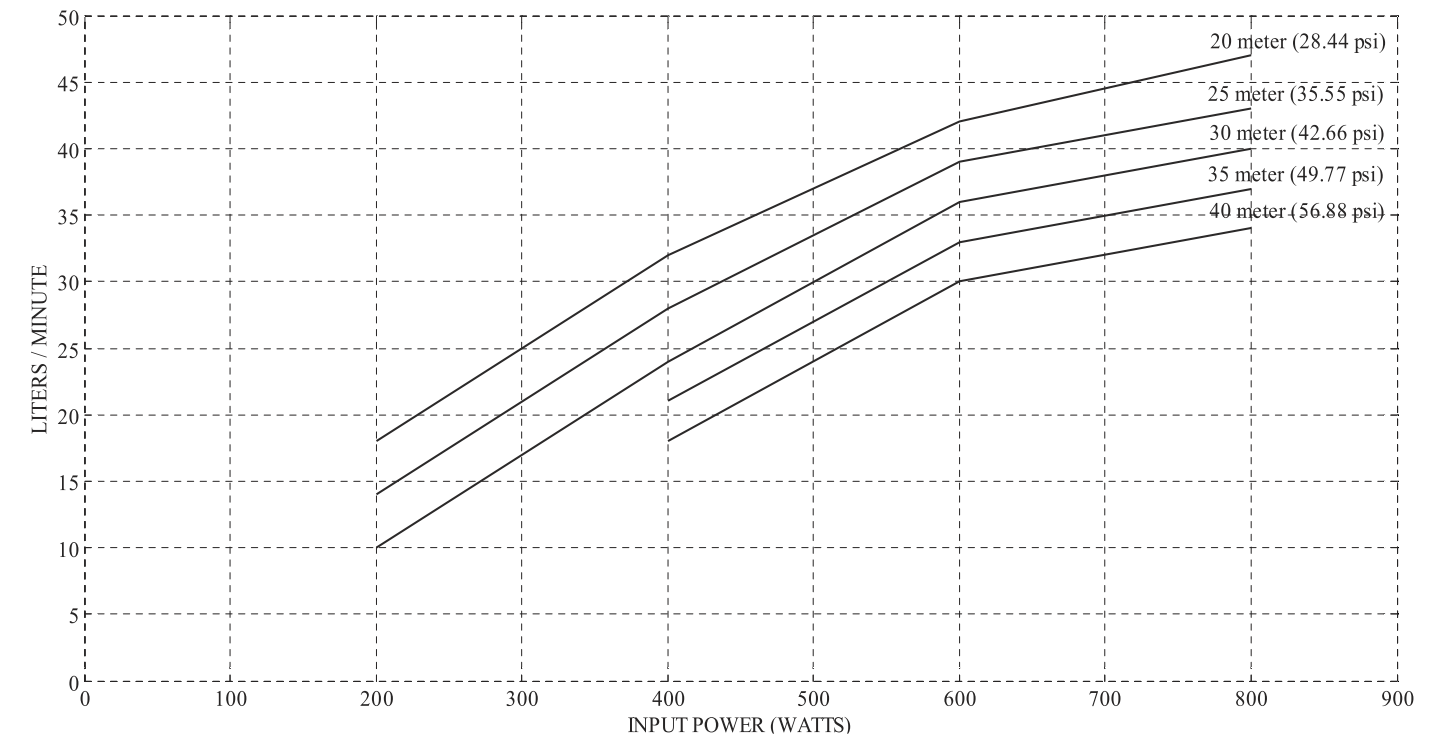

	INPUT POWER (WATTS)			
	800	600	400	200
HEAD (M)	FLOW RATE (LITERS / MINUTE)			
20	47	42	32	18
25	43	39	28	14
30	40	36	24	10
35	37	33	21	
40	34	30	18	

**PUMP PERFORMANCE SSP900 - 50 - 13**

**MOTOR 1 HP**

110 Volt Motor – (4"x4") – BSP 1.25"  
Maximum OD 4" – Material Code 9500000062

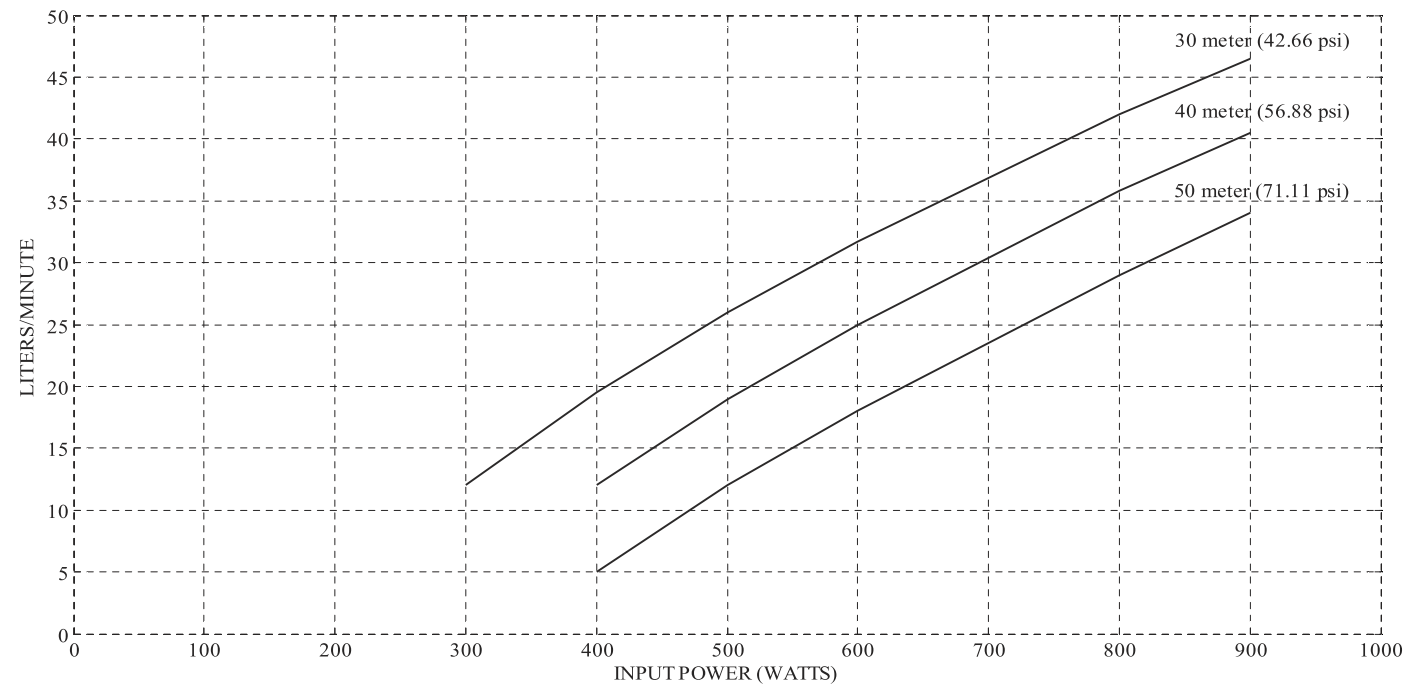

	INPUT POWER (WATTS)					
	900	800	600	500	400	300
HEAD (M)	FLOW RATE (LITERS / MINUTE)					
30	47	42	32	26	20	12
40	41	36	25	19	12	
50	34	29	18	12	05	



**PUMP PERFORMANCE SSP1000 - 10 - 102**

**MOTOR 1 HP**

110 Volt Motor – (4"x6") – BSP 2"  
Maximum OD 6" – Material Code 9500000098

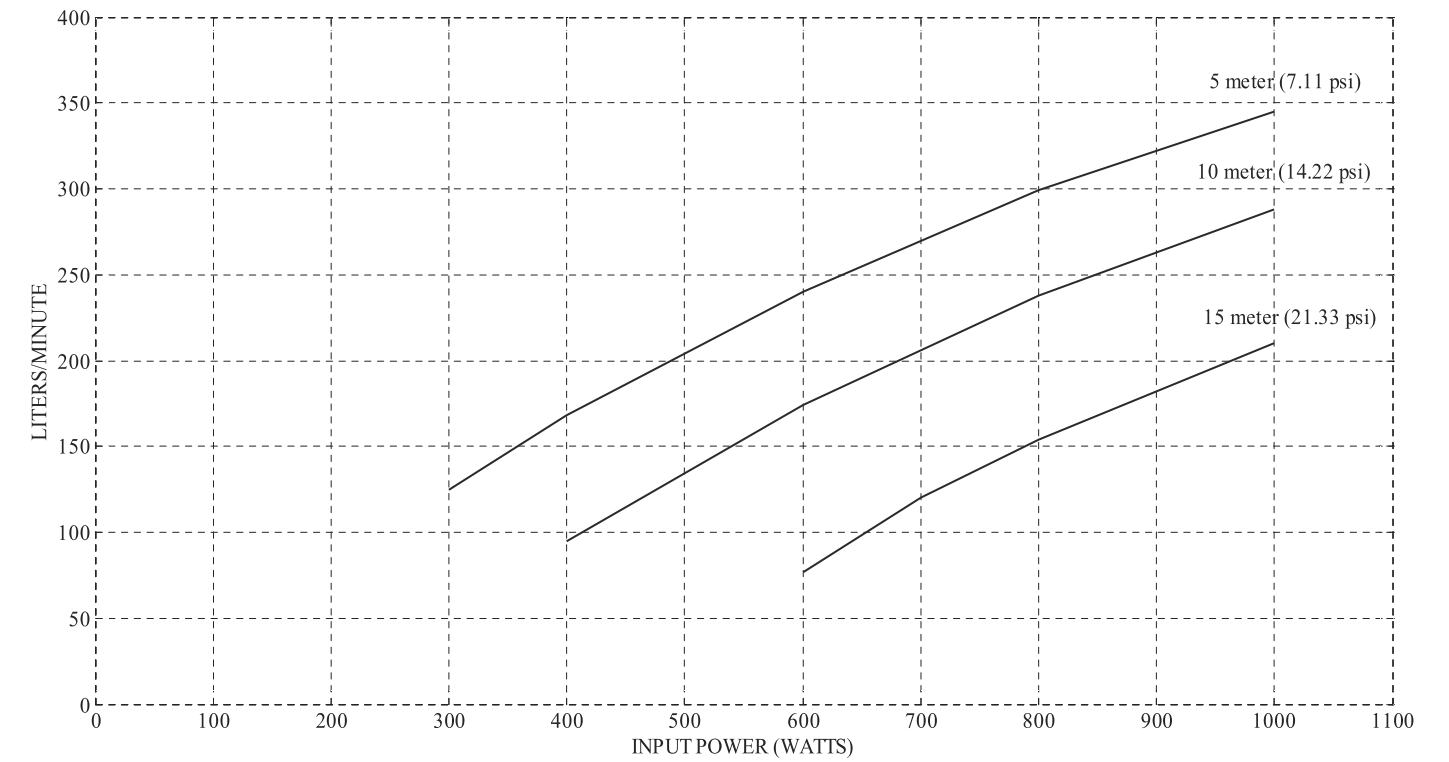

	INPUT POWER (WATTS)				
	1000	800	600	400	300
HEAD (M)	FLOW RATE (LITERS / MINUTE)				
05	345	299	240	168	125
10	288	238	174	95	
15	210	154	77		



**PUMP PERFORMANCE SSP1000 - 30 - 29**

**MOTOR 1 HP**

110 Volt Motor – (4"x4") – BSP 1.5"  
 Maximum OD 4" – Material Code 9500000092

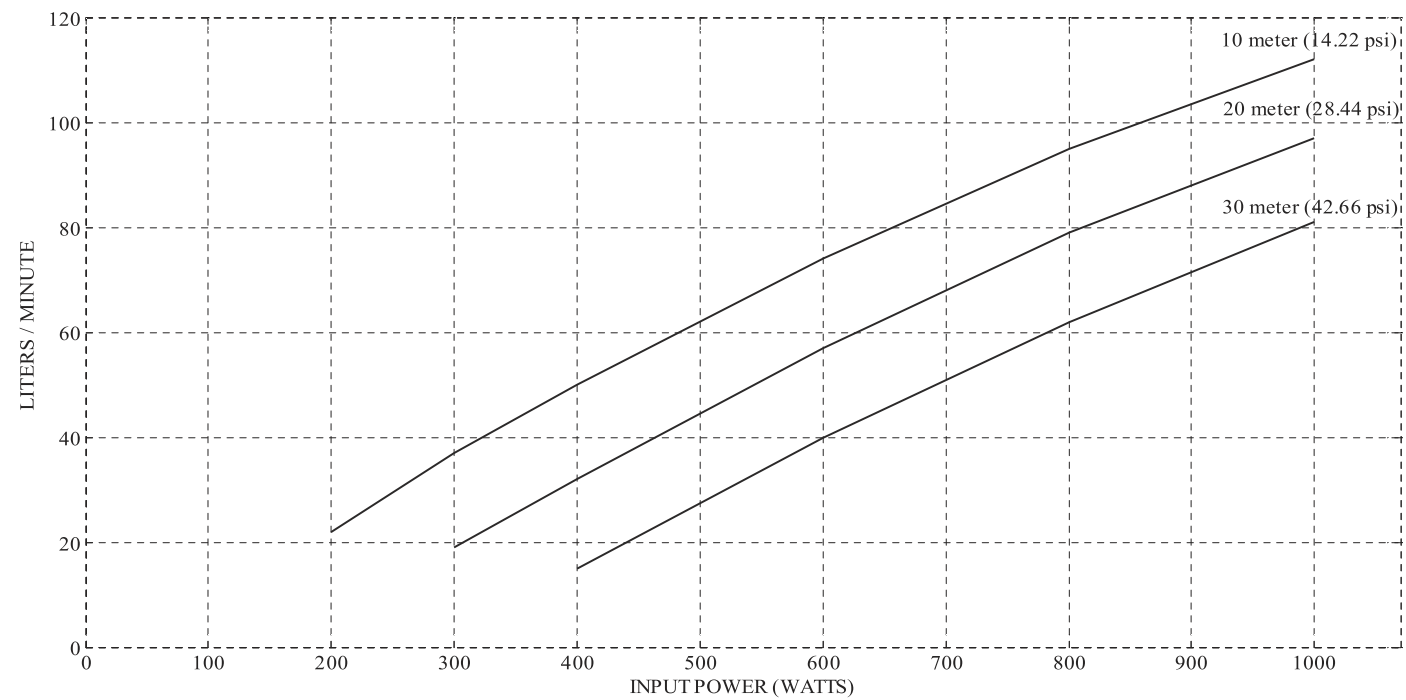

	INPUT POWER (WATTS)					
	1000	800	600	400	300	200
HEAD (M)	FLOW RATE (LITERS / MINUTE)					
10	112	95	74	50	37	22
20	97	79	57	32	19	
30	81	62	40	15		



**PUMP PERFORMANCE SSP1000 - 70 - 7**

**MOTOR 1 HP**

110 Volt Motor – (4"x4") – BSP 1.25"  
 Maximum OD 4" – Material Code 9500000060

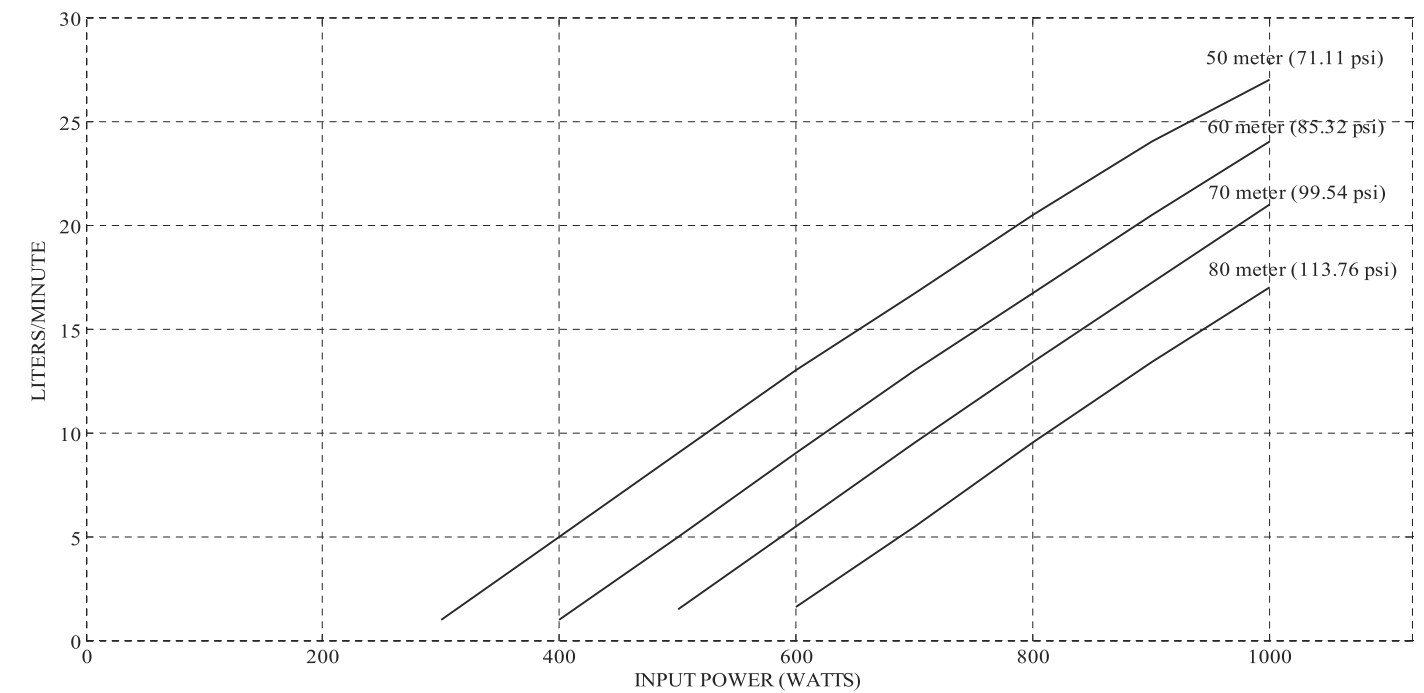

	INPUT POWER (WATTS)							
	1000	900	800	700	600	500	400	300
HEAD (M)	FLOW RATE (LITERS / MINUTE)							
50	27	24	20	17	13	9	5	1
60	24	20	17	13	9	5	1	
70	21	17	13	10	5	2		
80	17	13	9	5	2			

**PUMP PERFORMANCE SSP1200 - 20 - 44**

**MOTOR 1 HP**

110 Volt Motor – (4"x4") – BSP 2"  
Maximum OD 4" – Material Code 9500000037

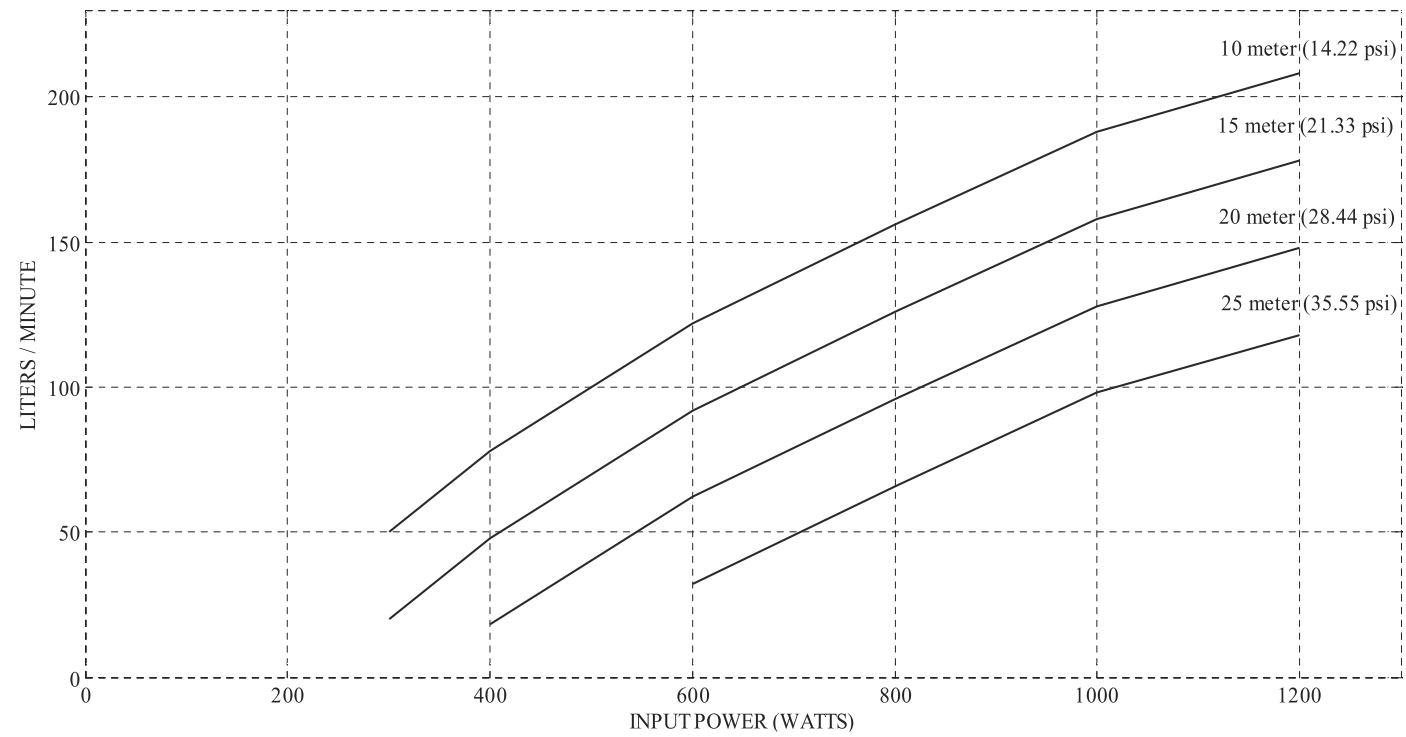

	INPUT POWER (WATTS)					
	1200	1000	800	600	400	300
HEAD (M)	FLOW RATE (LITERS / MINUTE)					
10	208	188	156	122	78	50
15	178	158	126	92	48	20
20	148	128	96	62	18	
25	118	98	66	32		



**PUMP PERFORMANCE SSP1200 - 35 - 26**

**MOTOR 1 HP**

110 Volt Motor – (4"x4") – BSP 1.5"  
Maximum OD 4" – Material Code 9500000028

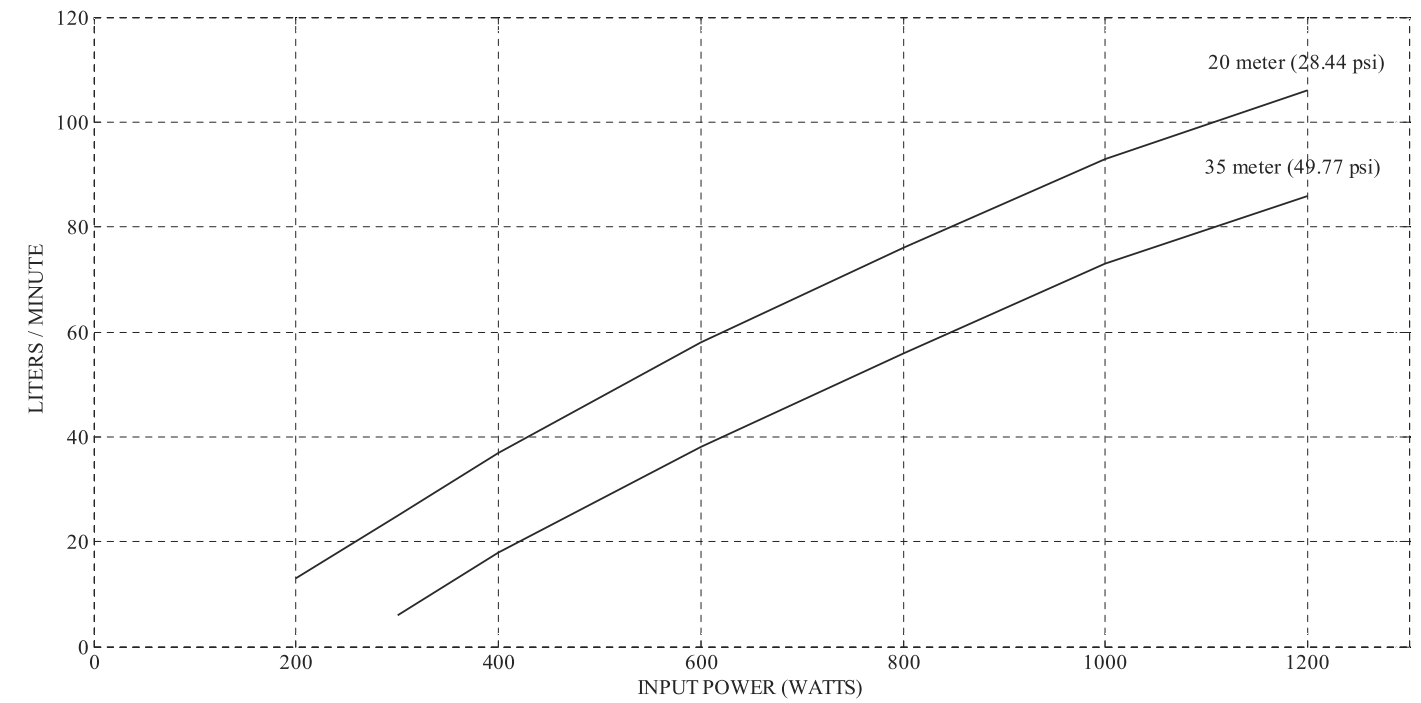

	INPUT POWER (WATTS)						
	1200	1000	800	600	400	300	200
HEAD (M)	FLOW RATE (LITERS / MINUTE)						
20	106	93	76	58	37	25	13
35	86	73	56	38	18	6	

**PUMP PERFORMANCE SSP1200 - 40 - 19**

**MOTOR 1 HP**

110 Volt Motor – (4"x4") – BSP 1.25"  
 Maximum OD 4" – Material Code 9500000093

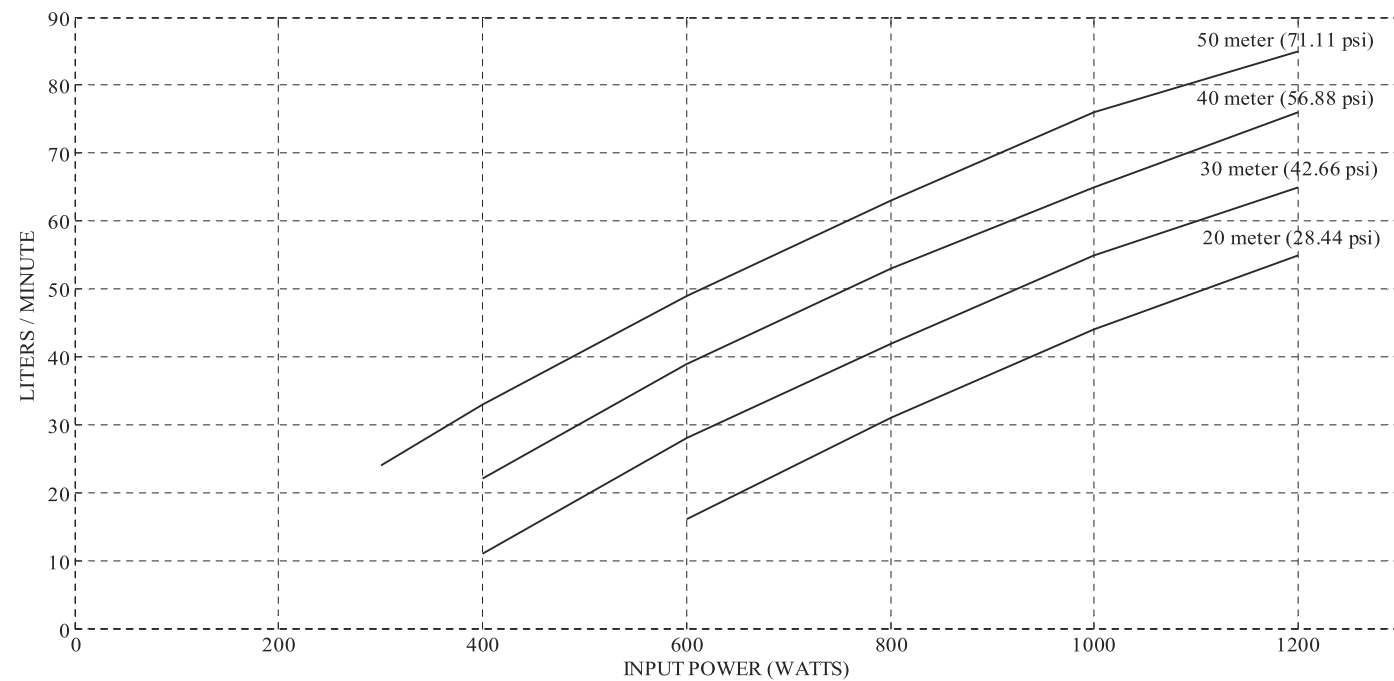

HEAD (M)	INPUT POWER (WATTS)					
	1200	1000	800	600	400	300
20	85	76	63	49	33	24
30	76	65	53	39	22	
40	65	55	42	28	11	
50	55	44	31	16		



**PUMP PERFORMANCE SSP1200 - 70 - 10**

**MOTOR 1 HP**

110 Volt Motor – (4"x4") – BSP 1.25"  
 Maximum OD 4" – Material Code 9500000017

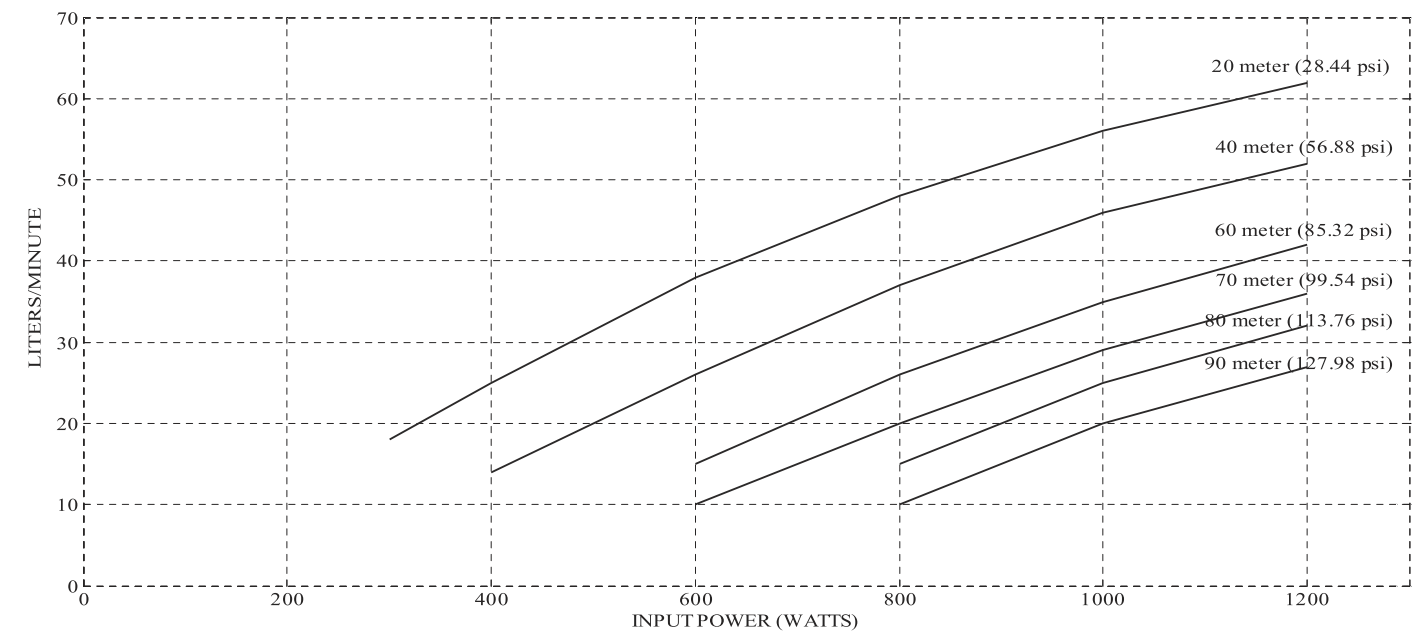

HEAD (M)	INPUT POWER (WATTS)					
	1200	1000	800	600	400	300
20	62	56	48	38	25	18
40	52	46	37	26	14	
60	42	35	26	15		
70	36	29	20	10		
80	32	25	15			
90	27	20	10			

**PUMP PERFORMANCE SSP1200 - 90 - 6**

**MOTOR 1 HP**

200 Volt Motor – (4"x4") – BSP 1.25"  
 Maximum OD 4" – Material Code 9500000200

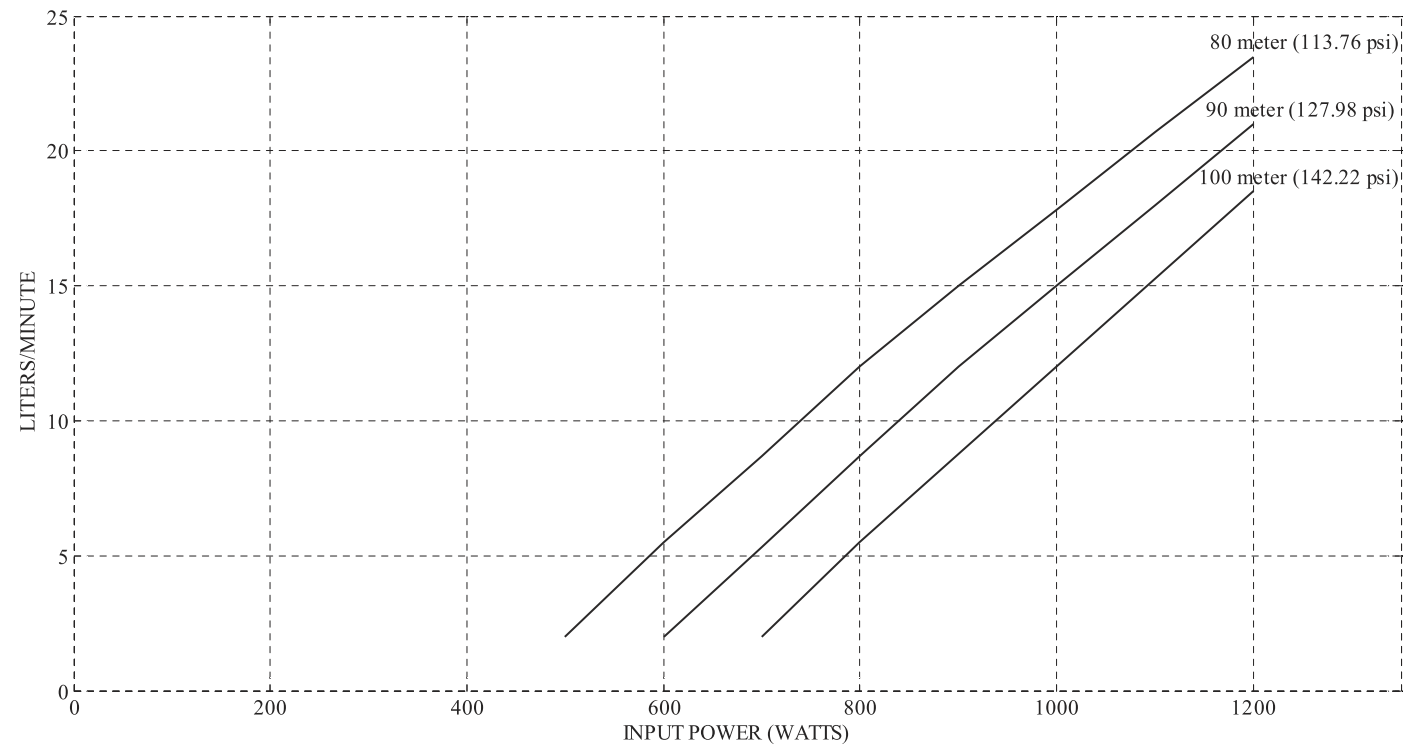

HEAD (M)	INPUT POWER (WATTS)							
	1200	1100	1000	900	800	700	600	500
80	24	21	18	15	12	9	6	2
90	21	18	15	12	9	5	2	
100	18	12	5	02				



**PUMP PERFORMANCE SSP1500 - 25 - 36**

**MOTOR 1.5 HP**

160 Volt Motor – (4"x4") – BSP 2"  
 Maximum OD 4" – Material Code 9500000038

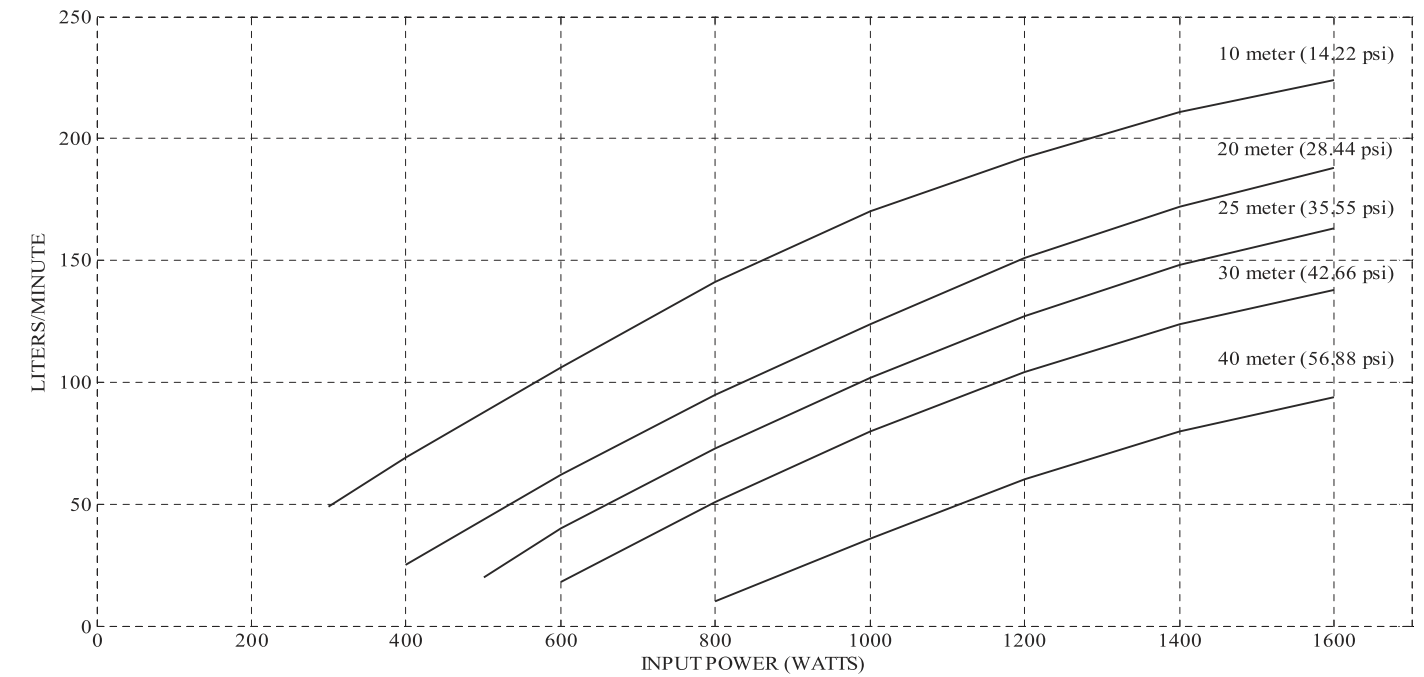

HEAD (M)	INPUT POWER (WATTS)							
	1600	1400	1200	1000	800	600	400	300
10	224	211	192	170	141	106	69	49
20	188	172	151	124	95	62	25	
25	163	148	127	102	73	40		
30	138	124	104	80	51	18		
40	94	80	60	36	10			

**PUMP PERFORMANCE SSP1500 - 40 - 22**

**MOTOR 1.5 HP**

160 Volt Motor – (4"x4") – BSP 1.5"  
 Maximum OD 4" – Material Code 9500000029

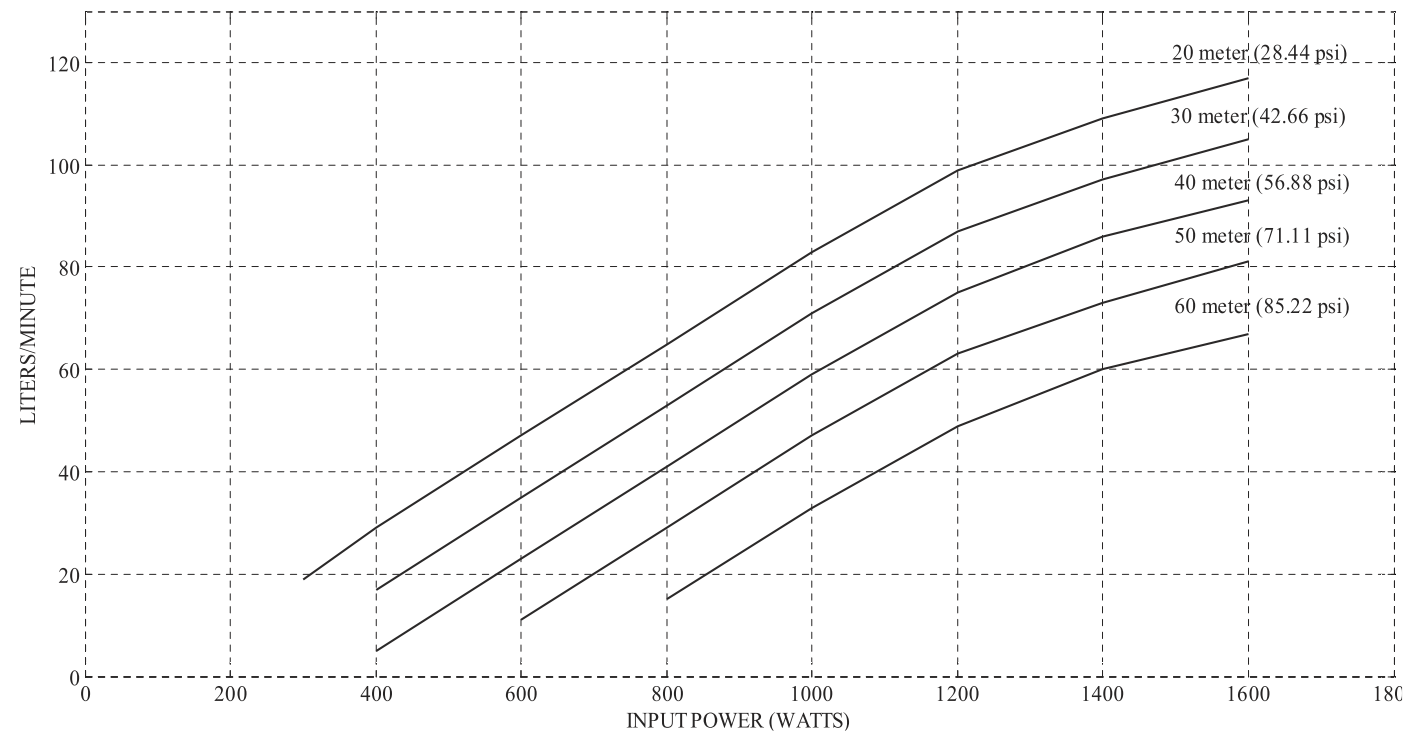

	INPUT POWER (WATTS)							
	1600	1400	1200	1000	800	600	400	300
HEAD (M)	FLOW RATE (LITERS / MINUTE)							
20	117	109	99	83	65	47	29	19
30	105	97	87	71	53	35	17	
40	93	86	75	59	41	23	5	
50	81	73	63	47	29	11		
60	67	60	49	33	13			



**PUMP PERFORMANCE SSP1500 - 70 - 13**

**MOTOR 1.5 HP**

160 Volt Motor – (4"x4") – BSP 1.25"  
 Maximum OD 4" – Material Code 9500000023

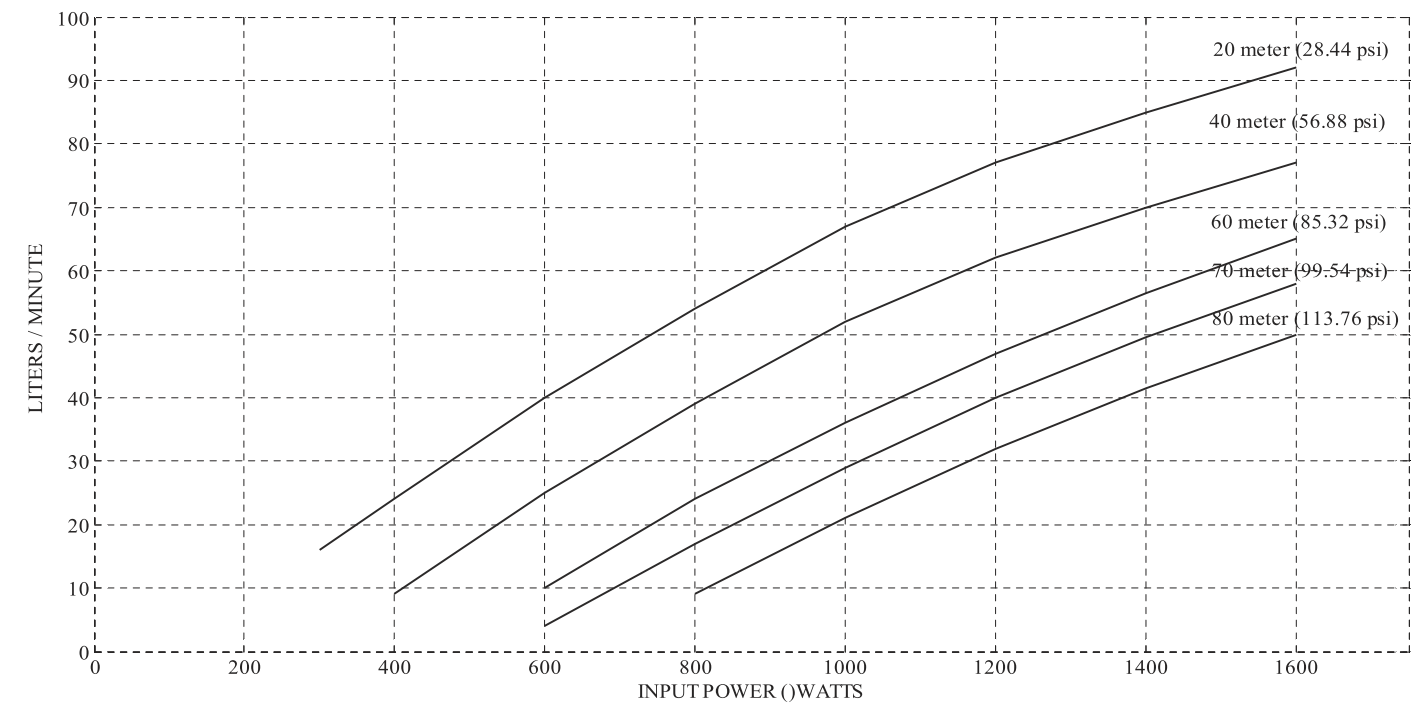

	INPUT POWER (WATTS)							
	1600	1400	1200	1000	800	600	400	300
HEAD (M)	FLOW RATE (LITERS / MINUTE)							
20	92	85	77	67	54	40	24	16
40	77	70	62	52	39	25	9	
60	65	56	47	37	24	10		
70	58	49	40	30	17	4		
80	50	41	32	21	9			

**PUMP PERFORMANCE SSP1500 - 90 - 8**

**MOTOR 1.5 HP**

160 Volt Motor – (4"x4") – BSP 1.25"  
 Maximum OD 4" – Material Code 9500000018

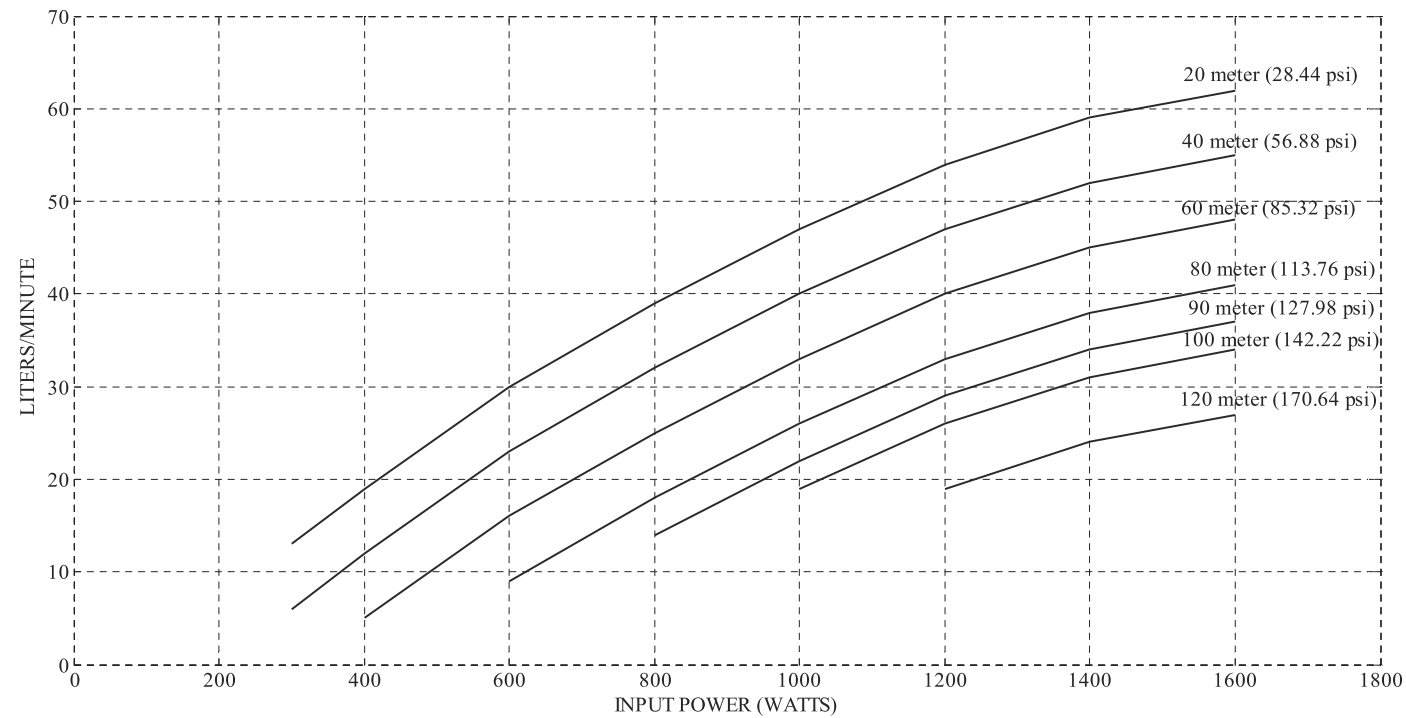

	INPUT POWER (WATTS)							
	1600	1400	1200	1000	800	600	400	300
HEAD (M)	FLOW RATE (LITERS / MINUTE)							
20	62	59	54	47	39	30	19	13
40	55	52	47	40	32	23	12	6
60	48	45	40	33	25	16	5	
80	41	38	33	26	18	9		
90	37	34	29	22	14			
100	34	31	26	19				
120	27	24	19					



**PUMP PERFORMANCE SSP2000 - 10 - 93**

**MOTOR 2.0 HP**

160 Volt Motor – (4"x6") – BSP 2.5"  
 Maximum OD 6" – Material Code 9500000074

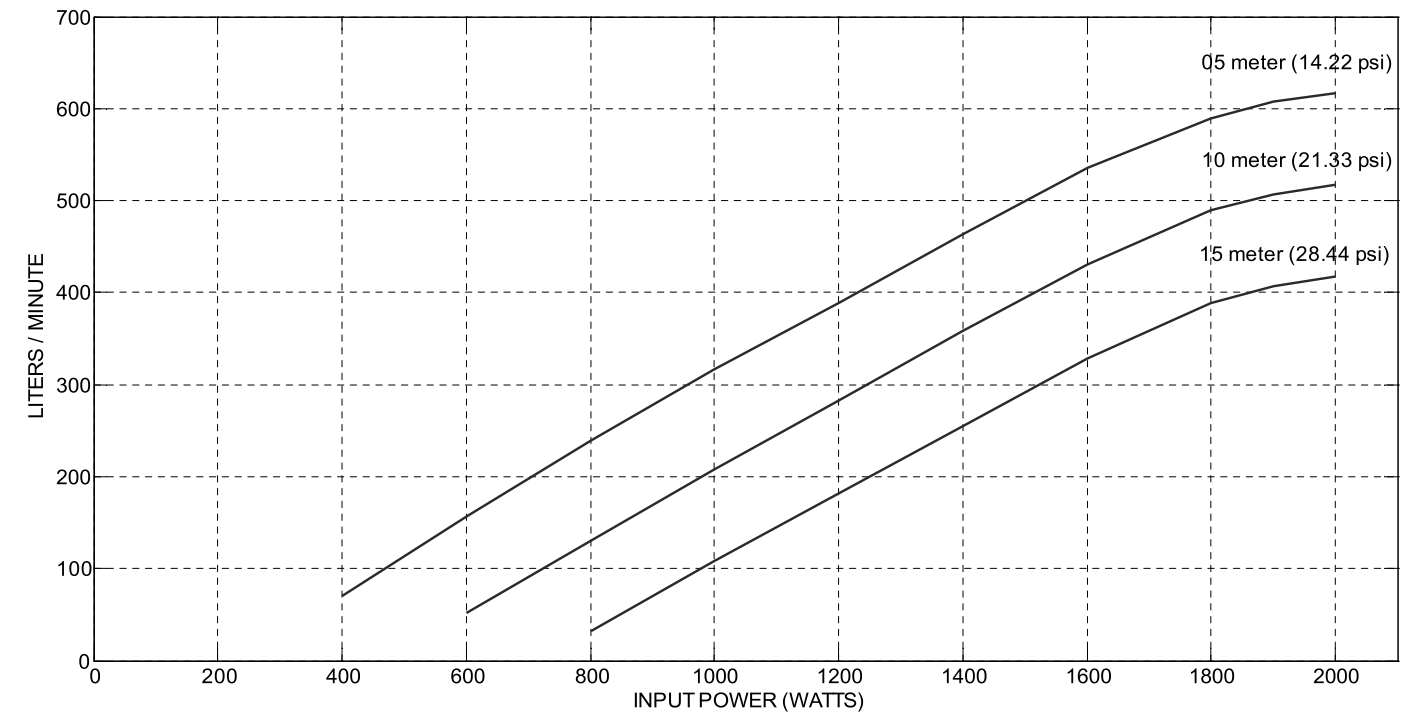

	INPUT POWER (WATTS)								
	2000	1800	1600	1400	1200	1000	800	600	400
HEAD (M)	FLOW RATE (LITERS / MINUTE)								
05	617	589	536	463	389	317	239	157	70
10	517	489	430	359	283	208	131	52	
15	417	389	328	255	182	108	32		

**PUMP PERFORMANCE SSP2000 - 20 - 52**

**MOTOR 2.0 HP**

160 Volt Motor – (4"x6") – BSP 2"  
 Maximum OD 6" – Material Code 9500000094

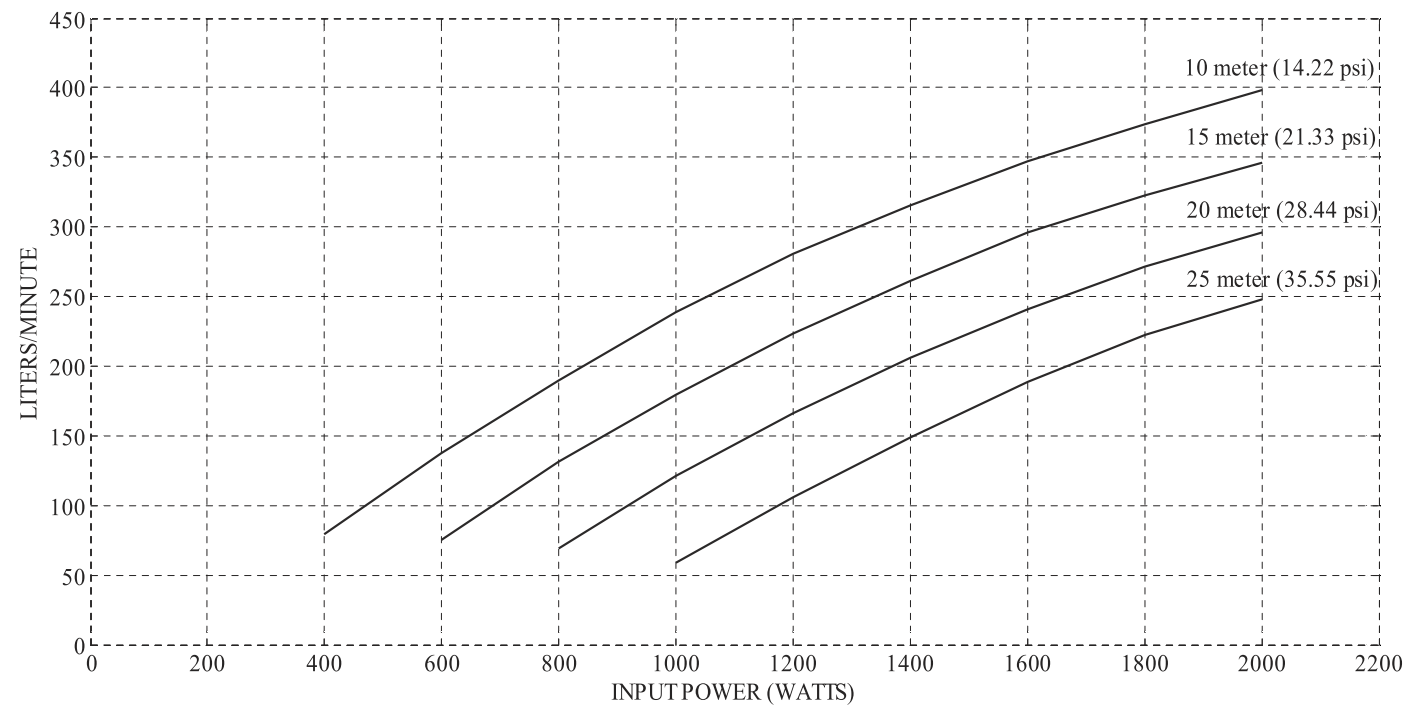

	INPUT POWER (WATTS)								
	2000	1800	1600	1400	1200	1000	800	600	400
HEAD (M)	FLOW RATE (LITERE / MINUTE)								
10	398	374	347	316	281	239	190	138	79
15	346	323	296	261	223	180	131	75	
20	296	272	241	206	166	121	69		
25	248	222	189	149	106	59			



**PUMP PERFORMANCE SSP2000 - 30 - 37**

**MOTOR 2.0 HP**

160 Volt Motor – (6"x6") – BSP 2"  
 Maximum OD 6" – Material Code 9500000402

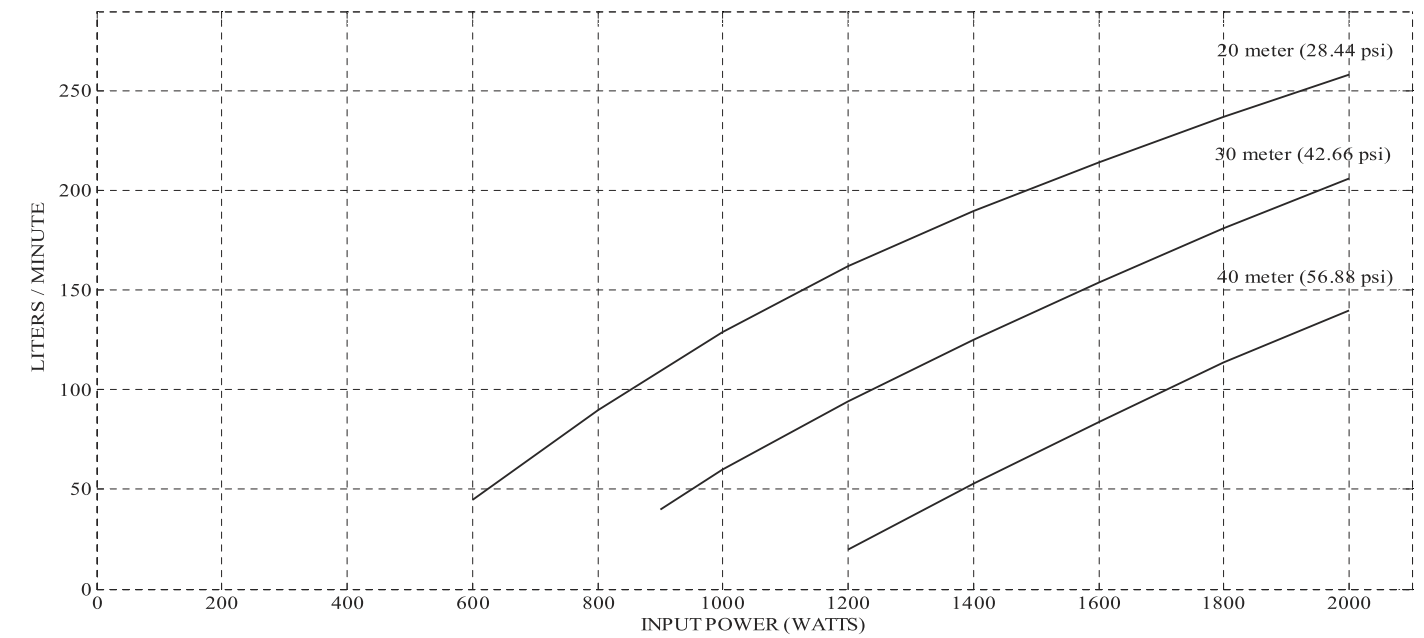

	INPUT POWER (WATTS)							
	2000	1800	1600	1400	1200	1000	800	600
HEAD (M)	FLOW RATE (LITERS / MINUTE)							
20	258	237	214	190	162	129	90	45
30	206	181	154	125	94	60	40	
40	140	114	84	53	20			

**PUMP PERFORMANCE SSP2000 - 40 - 23**

**MOTOR 2 HP**

160 Volt Motor – (4"x4") – BSP 2"  
 Maximum OD 4" – Material Code 9500000095

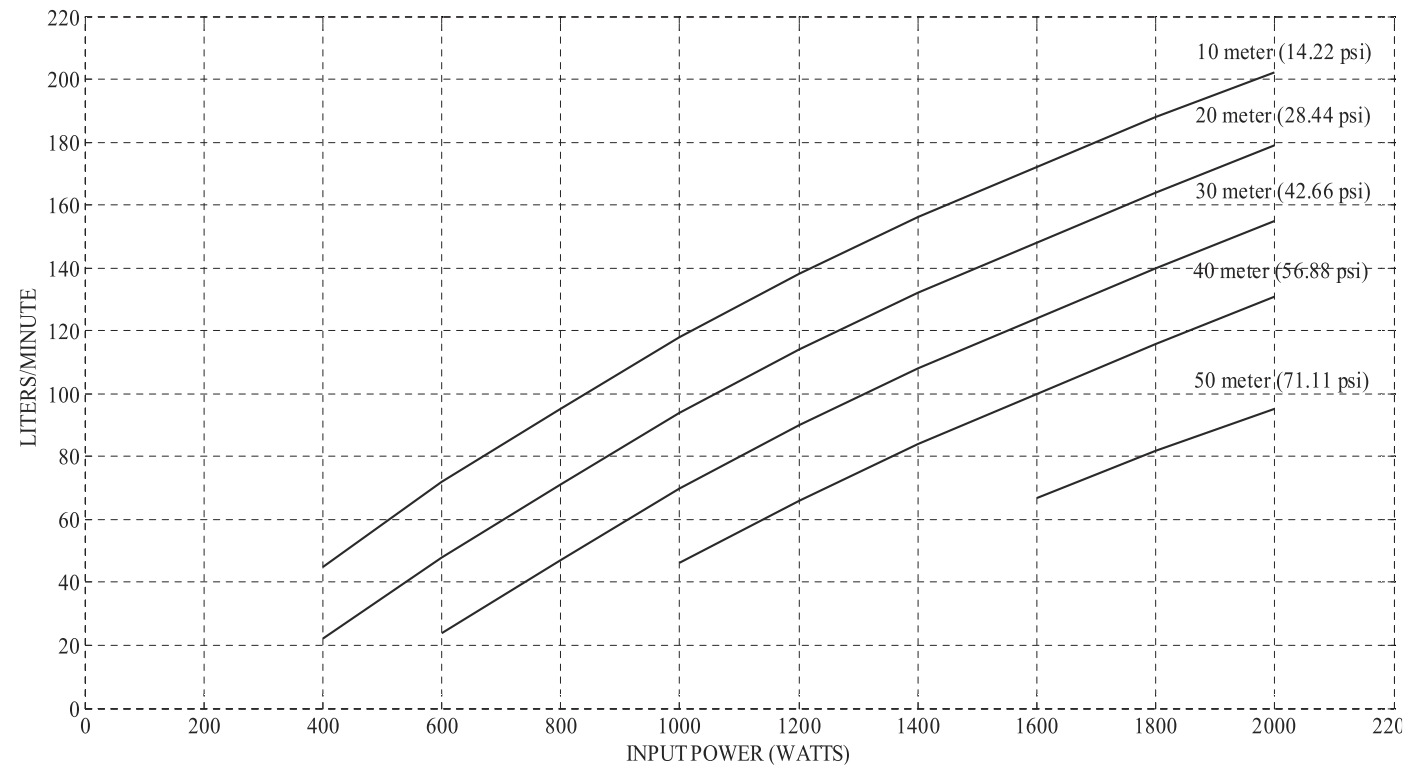

	INPUT POWER (WATTS)								
	2000	1800	1600	1400	1200	1000	800	600	400
HEAD (M)	FLOW RATE (LITERS / MINUTE)								
10	202	188	172	156	138	118	95	72	45
20	179	164	148	132	114	94	71	48	22
30	155	140	124	108	90	70	47	24	
40	131	116	100	84	66	46			
50	95	82	67						



**PUMP PERFORMANCE SSP2000 - 60 - 15**

**MOTOR 2 HP**

160 Volt Motor – (4"x4") – BSP 1.5"  
 Maximum OD 4" – Material Code 9500000030

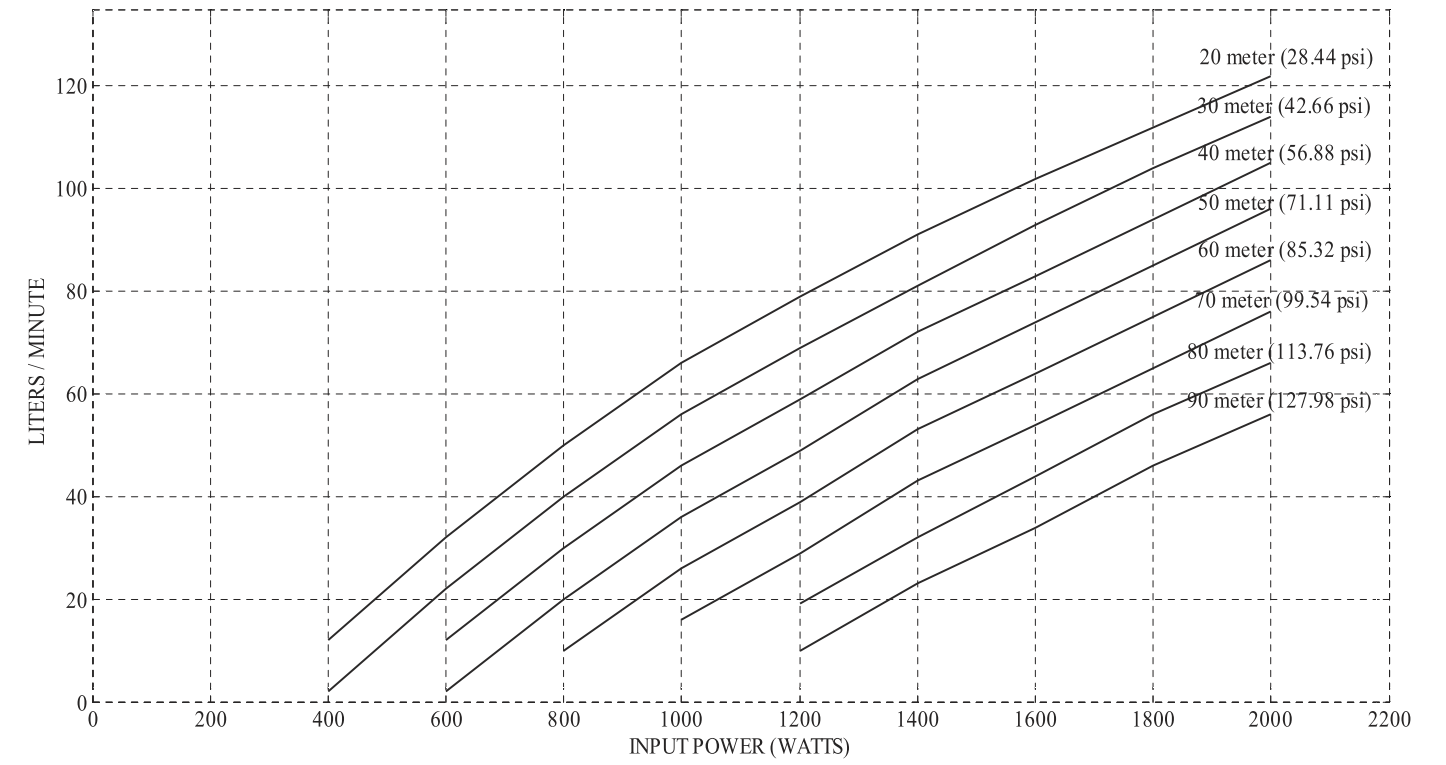

	INPUT POWER (WATTS)								
	2000	1800	1600	1400	1200	1000	800	600	400
HEAD (M)	FLOW RATE (LITERS / MINUTE)								
20	122	112	102	91	79	66	50	32	12
30	114	104	93	81	69	56	40	22	02
40	105	94	83	72	59	46	30	12	
50	96	85	74	63	49	36	20	02	
60	86	75	64	53	39	26	10		
70	76	65	54	43	29	16			
80	66	56	44	32	19				
90	56	46	34	23	10				



**PUMP PERFORMANCE SSP2000 - 80 - 10**

**MOTOR 2 HP**

160 Volt Motor – (4"x4") – BSP 1.25"  
Maximum OD 4" – Material Code 9500000024

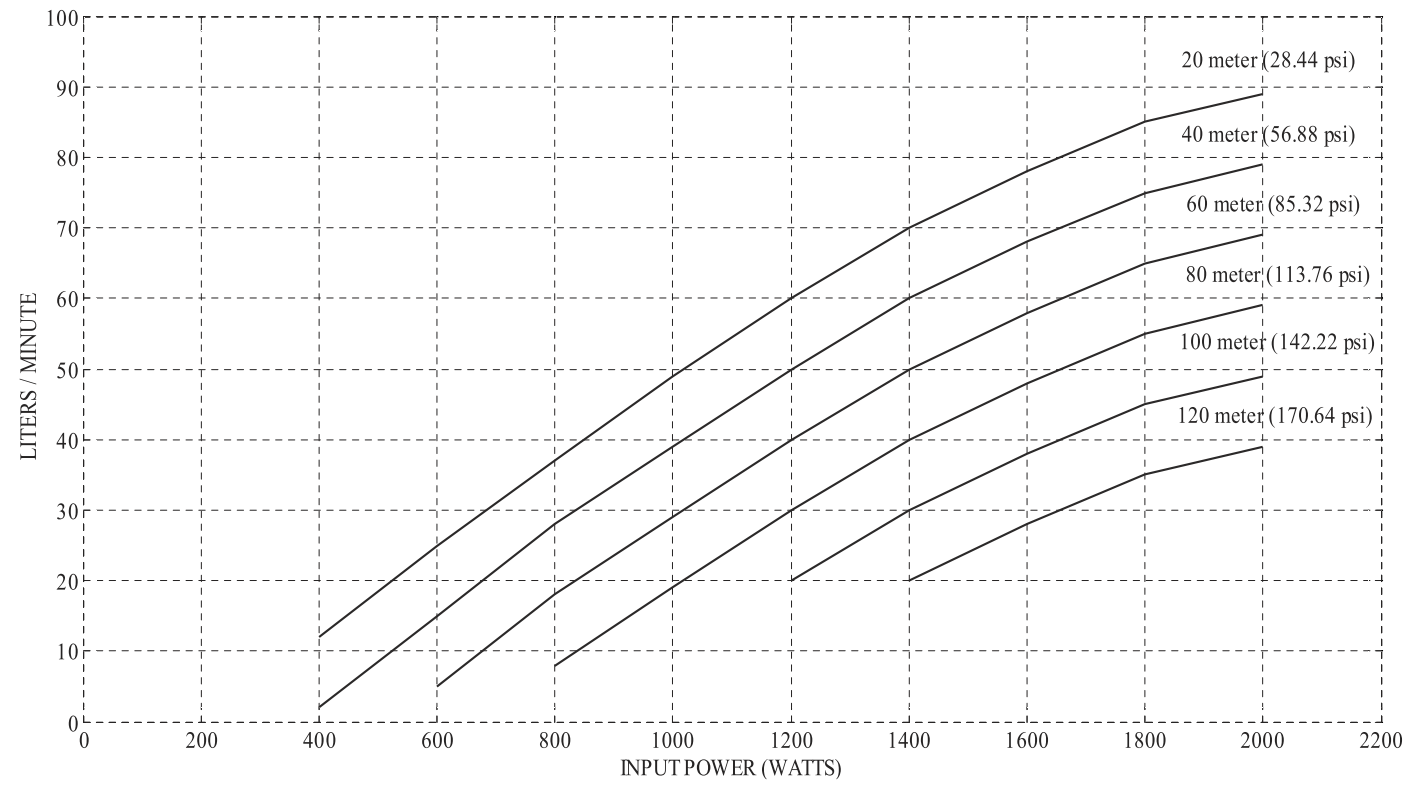

HEAD (M)	INPUT POWER (WATTS)								
	2000	1800	1600	1400	1200	1000	800	600	400
20	89	85	78	70	60	49	37	25	12
40	79	75	68	60	50	39	28	15	2
60	69	65	58	50	40	29	18	5	
80	59	55	48	40	30	19	8		
100	49	45	38	30	20				
120	39	35	28	20					



**PUMP PERFORMANCE SSP2000 - 90 - 9**

**MOTOR 2 HP**

160 Volt Motor – (4"x4") – BSP 1.25"  
Maximum OD 4" – Material Code 9500000025

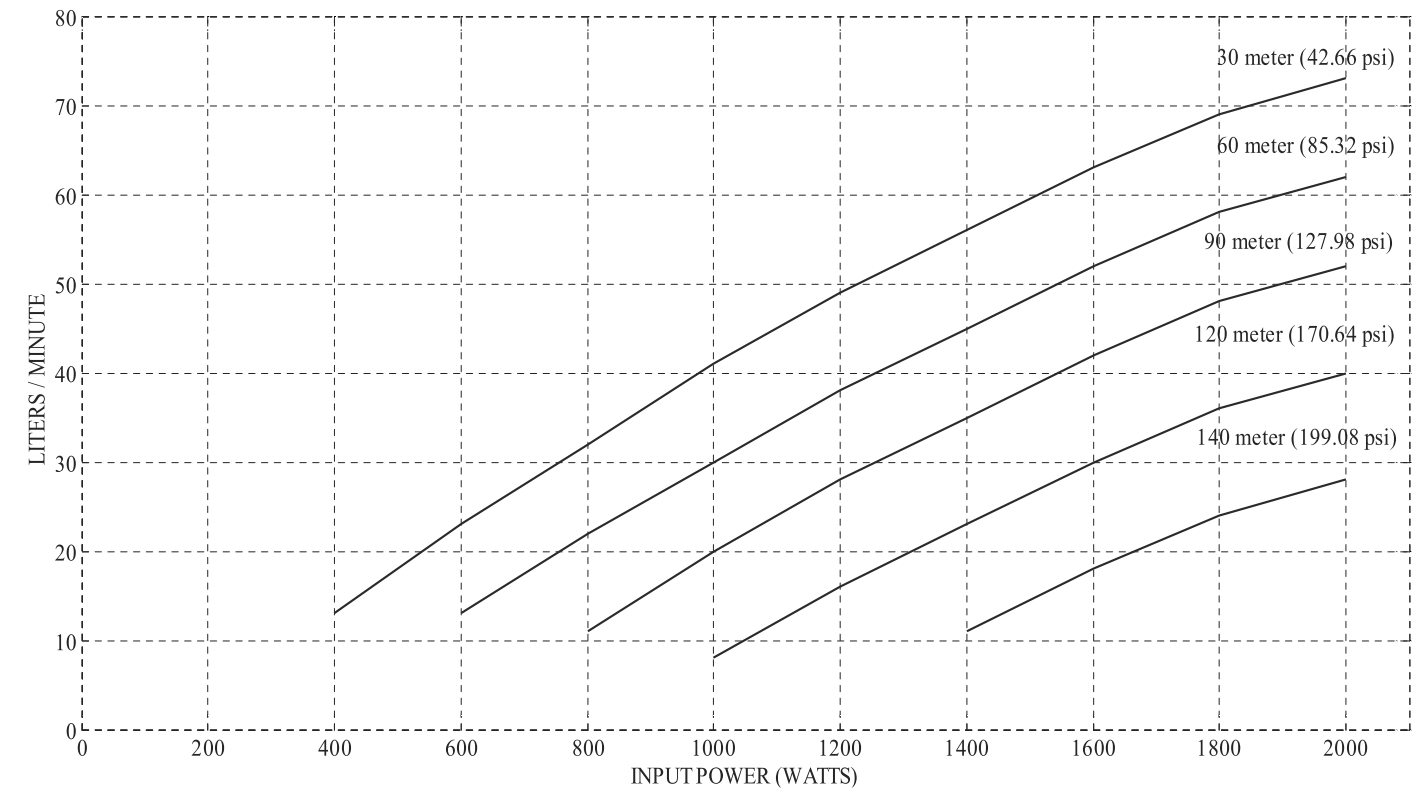

HEAD (M)	INPUT POWER (WATTS)								
	2000	1800	1600	1400	1200	1000	800	600	400
30	72	69	63	56	49	41	32	23	13
60	62	58	52	45	38	30	22	13	
90	52	48	42	35	28	20	11		
120	40	36	30	23	16	8			
140	28	24	18	11					

**PUMP PERFORMANCE SSP2000 - 120 - 6**

**MOTOR 2 HP**

160 Volt Motor – (4"x4") – BSP 1.25"  
Maximum OD 4" – Material Code 9500000019

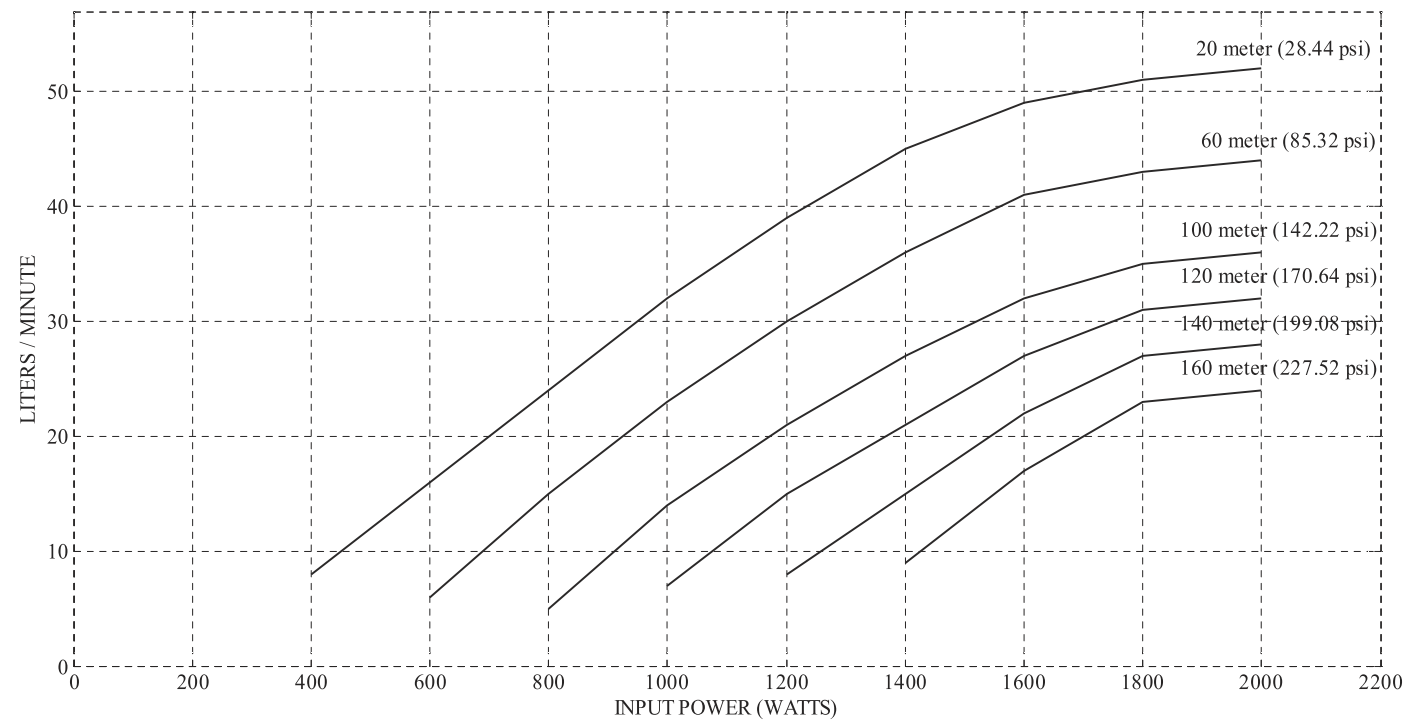

	INPUT POWER (WATTS)								
	2000	1800	1600	1400	1200	1000	800	600	400
HEAD (M)	FLOW RATE (LITERS / MINUTE)								
20	52	51	49	45	39	32	24	16	8
60	44	43	41	36	30	23	15	6	
100	36	35	32	27	21	14	5		
120	32	31	27	21	15	7			
140	28	27	22	15	8				
160	24	23	17	9					



**PUMP PERFORMANCE SSP2600 - 10 - 104**

**MOTOR 3 HP**

230 Volt Motor – (6"x6") – BSP 3"  
Maximum OD 6" – Material Code 9500000198

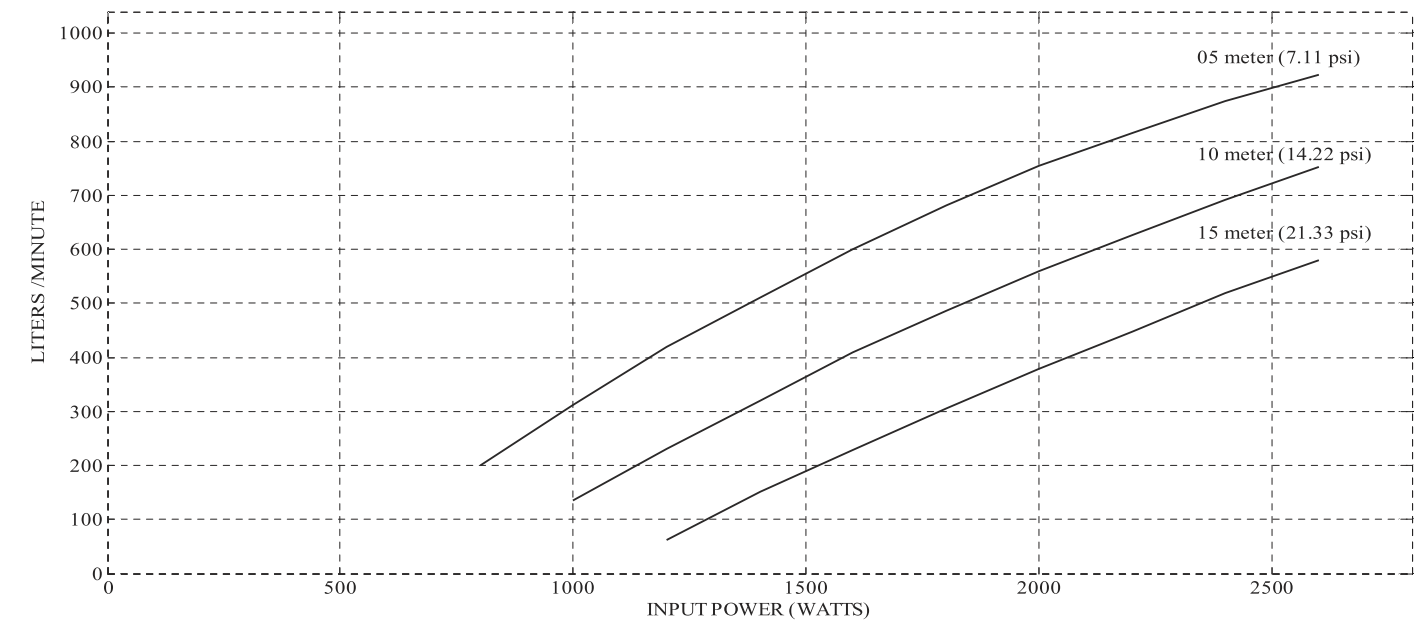

	INPUT POWER (WATTS)									
	2600	2400	2200	2000	1800	1600	1400	1200	1000	800
HEAD (M)	FLOW RATE (LITERS / MINUTE)									
0.5	923	875	815	755	681	601	511	420	312	201
10	753	692	627	559	486	409	320	231	135	
15	579	518	448	378	305	228	151	62		

**PUMP PERFORMANCE SSP3000 - 10 - 120**

**MOTOR 3 HP**

230 Volt Motor – (6"x6") – BSP 4"  
 Maximum OD 6" – Material Code 9500000254

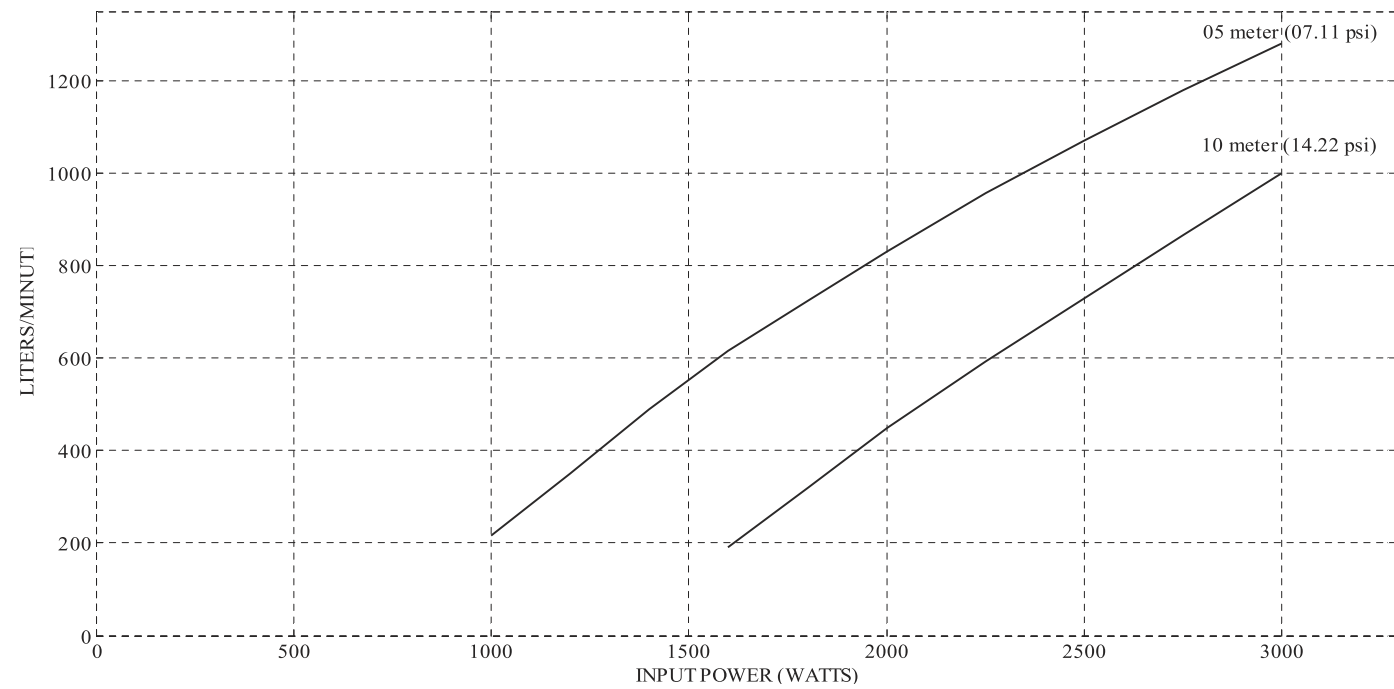

	INPUT POWER (WATTS)									
	3000	2750	2500	2250	2000	1800	1600	1400	1200	1000
HEAD (M)	FLOW RATE (LITERS / MINUTE)									
05	1280	1180	1070	956	830	725	615	490	349	217
10	1001	867	730	592	450	320	190			



**PUMP PERFORMANCE SSP3000 - 20 - 62**

**MOTOR 3 HP**

230 Volt Motor – (6"x6") – BSP 2.5"  
 Maximum OD 6" – Material Code 9500000115

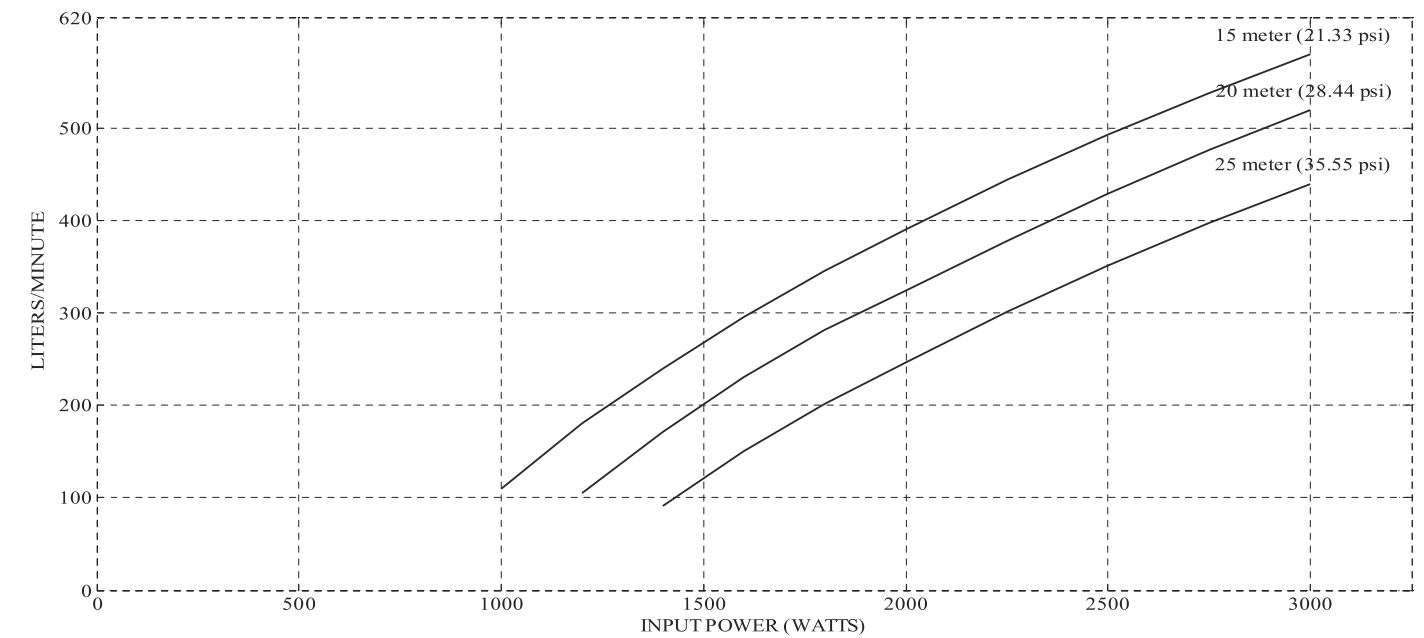

	INPUT POWER (WATTS)									
	3000	2750	2500	2250	2000	1800	1600	1400	1200	1000
HEAD (M)	FLOW RATE (LITERS / MINUTE)									
15	580	538	493	444	391	345	295	240	180	110
20	520	477	429	378	325	281	230	171	105	
25	440	398	351	301	247	201	150	91		

**PUMP PERFORMANCE SSP3000 - 25 - 44**

**MOTOR 3 HP**

230 Volt Motor – (6"x6") – BSP 2"  
Maximum OD 6" – Material Code 9500000179

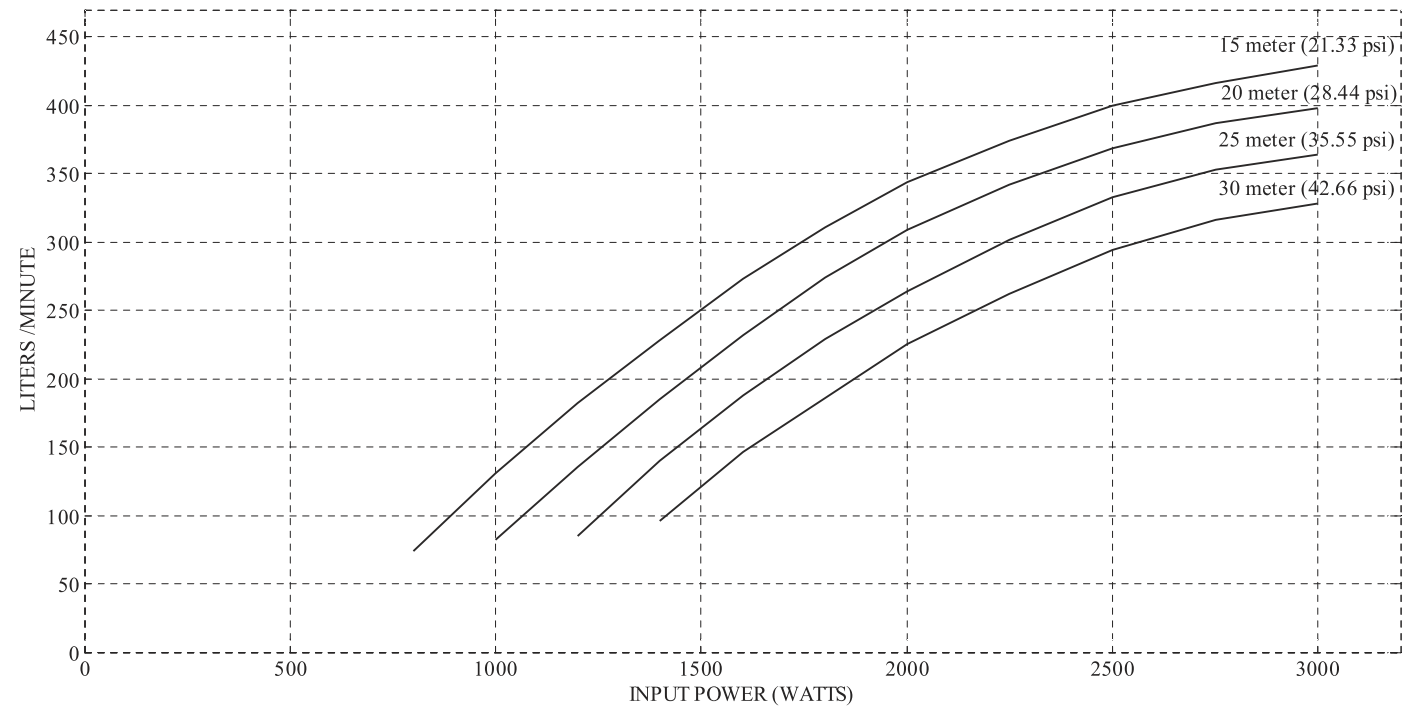

HEAD (M)	INPUT POWER (WATTS)										
	3000	2750	2500	2250	2000	1800	1600	1400	1200	1000	800
15	429	416	400	374	344	311	273	228	182	131	74
20	398	387	369	342	309	274	232	185	135	82	
25	364	353	333	302	264	229	188	140	85		
30	328	316	294	262	225	186	146	96			



**PUMP PERFORMANCE SSP3000 - 45 - 27**

**MOTOR 3 HP**

230 Volt Motor – (6"x6") – BSP 2.0"  
Maximum OD 6" – Material Code 9500000021

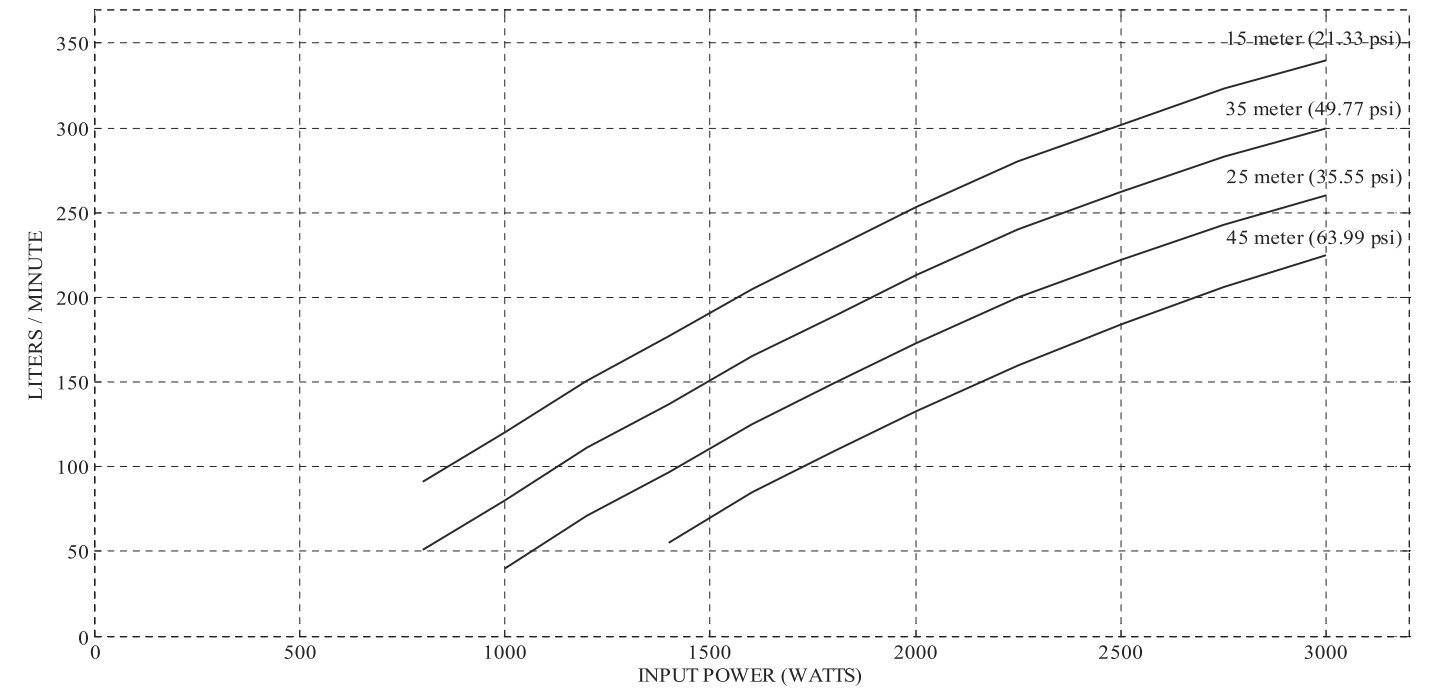

HEAD (M)	INPUT POWER (WATTS)										
	3000	2750	2500	2250	2000	1800	1600	1400	1200	1000	800
15	340	323	302	280	253	229	205	177	151	120	91
25	300	283	262	240	213	189	165	137	111	80	51
35	260	243	222	200	173	149	125	97	71	40	
45	225	206	184	160	133	109	85	55			

**PUMP PERFORMANCE SSP3000 - 50 - 19**

**MOTOR 3 HP**

230 Volt Motor – (6"x4") – BSP 2.0"  
Maximum OD 6" – Material Code 9500000205

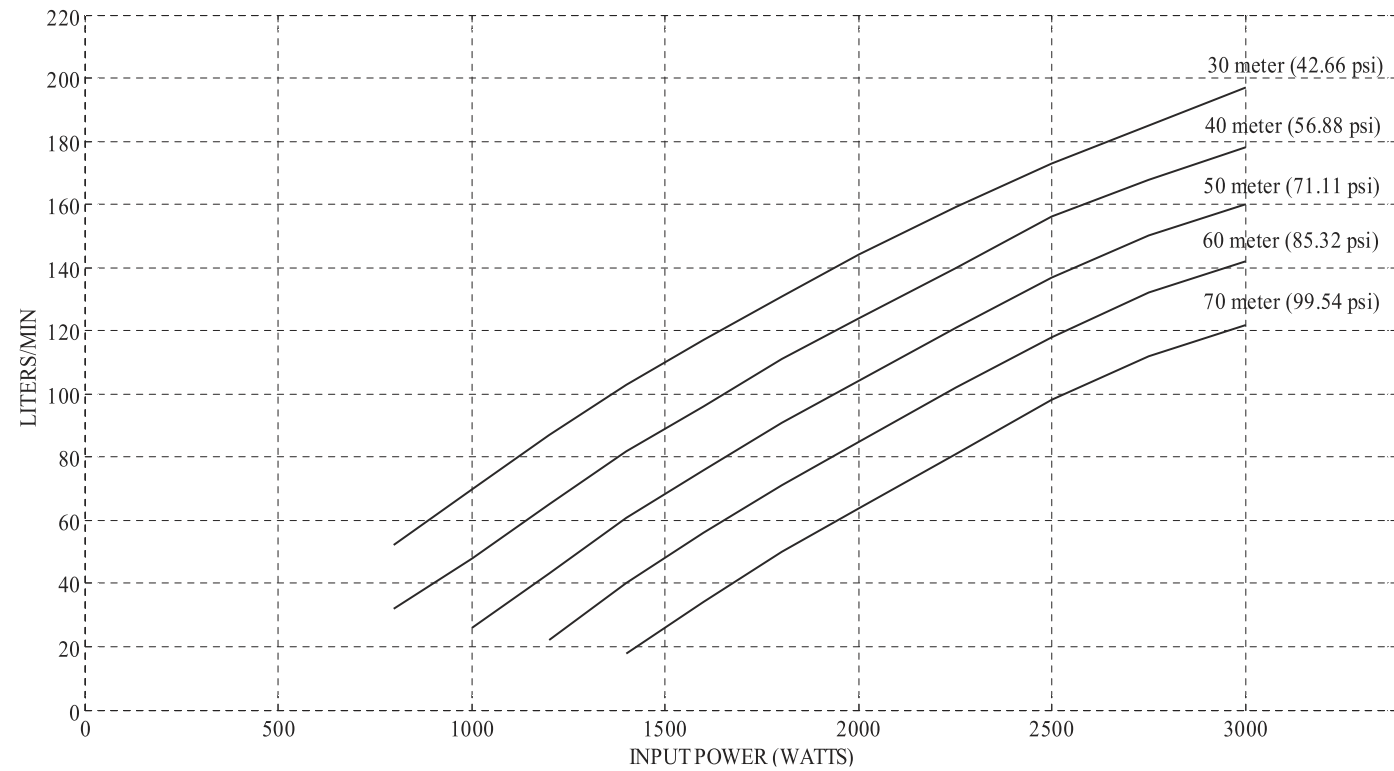

	INPUT POWER (WATTS)										
	3000	2750	2500	2250	2000	1800	1600	1400	1200	1000	800
HEAD (M)	FLOW RATE (LITERS / MINUTE)										
30	197	185	173	159	144	131	117	103	87	70	52
40	178	168	156	140	124	111	96	82	65	48	32
50	160	150	137	121	104	91	76	61	43	26	
60	142	132	118	102	85	71	56	40	22		
70	122	112	98	81	64	50	34	18			



**PUMP PERFORMANCE SSP3000 - 50 - 25**

**MOTOR 3 HP**

230 Volt Motor – (6"x6") – BSP 2"  
Maximum OD 6" – Material Code 9500000406

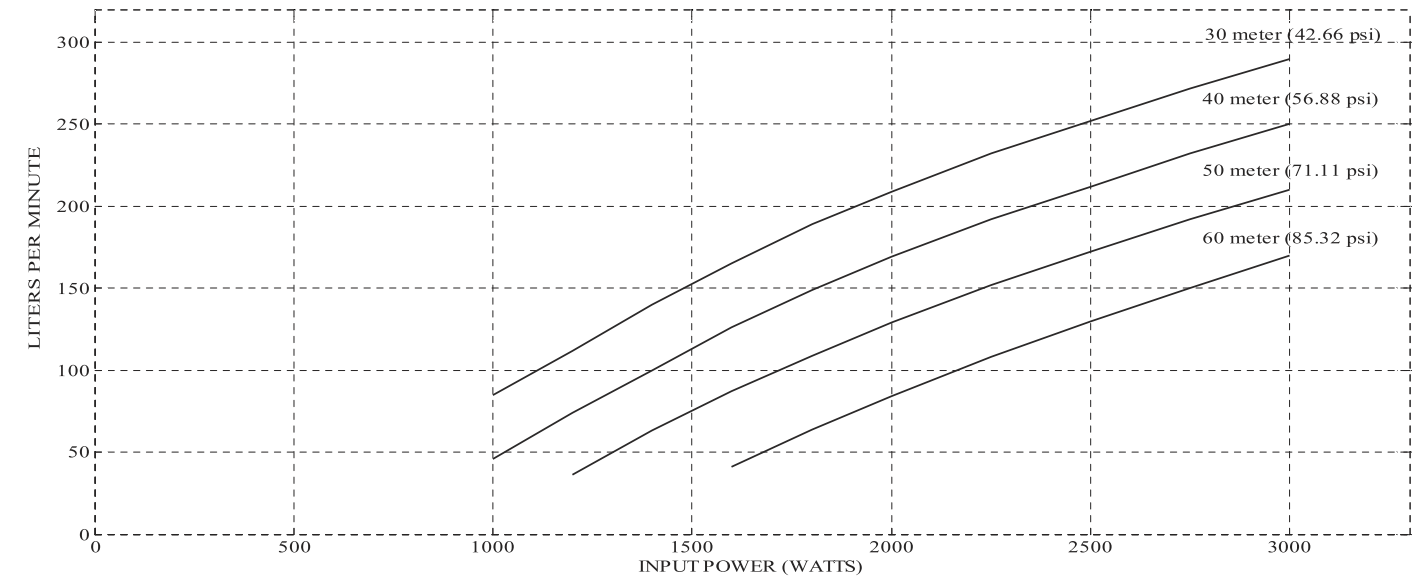

	INPUT POWER (WATTS)										
	3000	2750	2500	2250	2000	1800	1600	1400	1200	1000	
HEAD (M)	FLOW RATE (LITERS / MINUTE)										
30	290	272	252	232	209	189	165	140	112	85	
40	250	232	212	192	169	149	126	100	74	46	
50	210	192	172	152	129	109	87	63	36		
60	170	150	130	108	84	64	41				

**PUMP PERFORMANCE SSP3000 - 70 - 15**

**MOTOR 3 HP**

230 Volt Motor – (6"x4") – BSP 2"  
 Maximum OD 6" – Material Code 9500000049

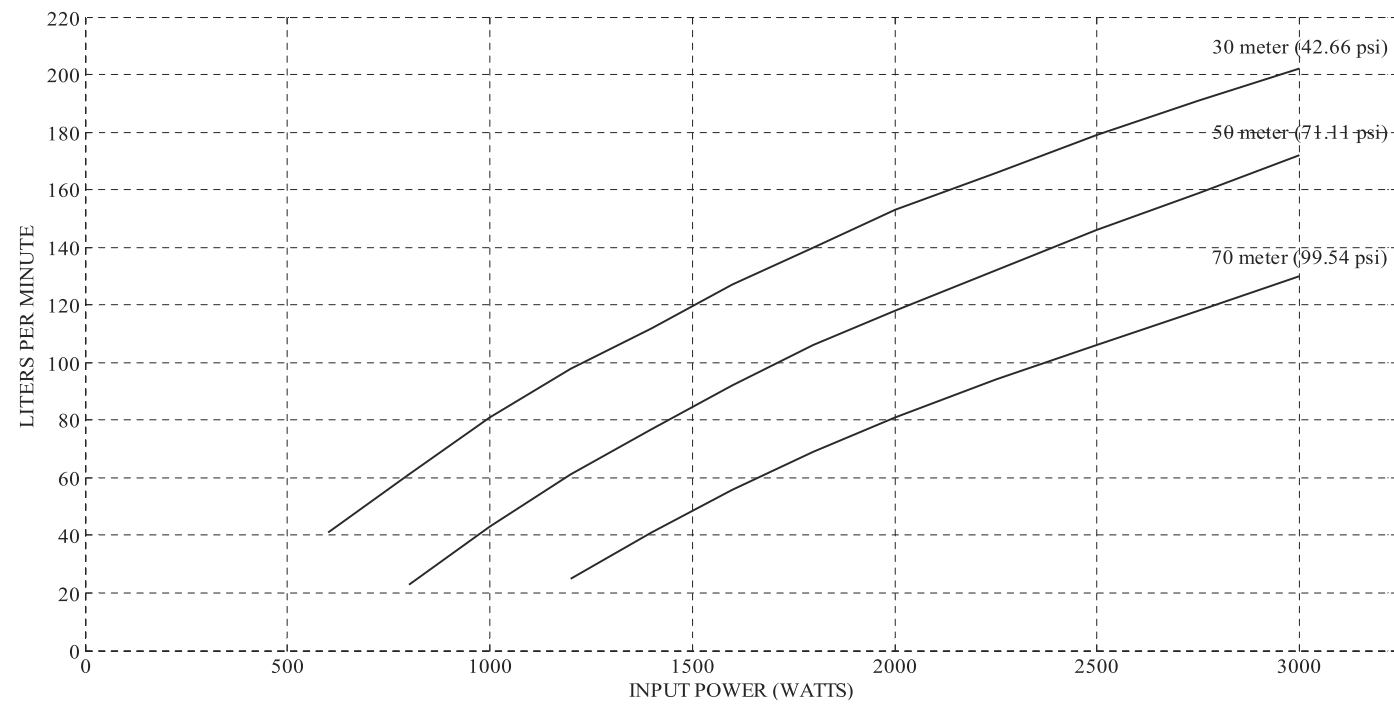

	INPUT POWER (WATTS)											
	3000	2750	2500	2250	2000	1800	1600	1400	1200	1000	800	600
HEAD (M)	FLOW RATE (LITERS / MINUTE)											
30	202	191	179	166	153	140	127	112	98	81	61	41
50	172	159	146	132	118	106	92	77	61	43	23	
70	130	118	106	94	81	69	56	41	25			



**PUMP PERFORMANCE SSP3000 - 100 - 10**

**MOTOR 3 HP**

230 Volt Motor – (6"x4") – BSP 1.5"  
 Maximum OD 6" – Material Code 9500000181

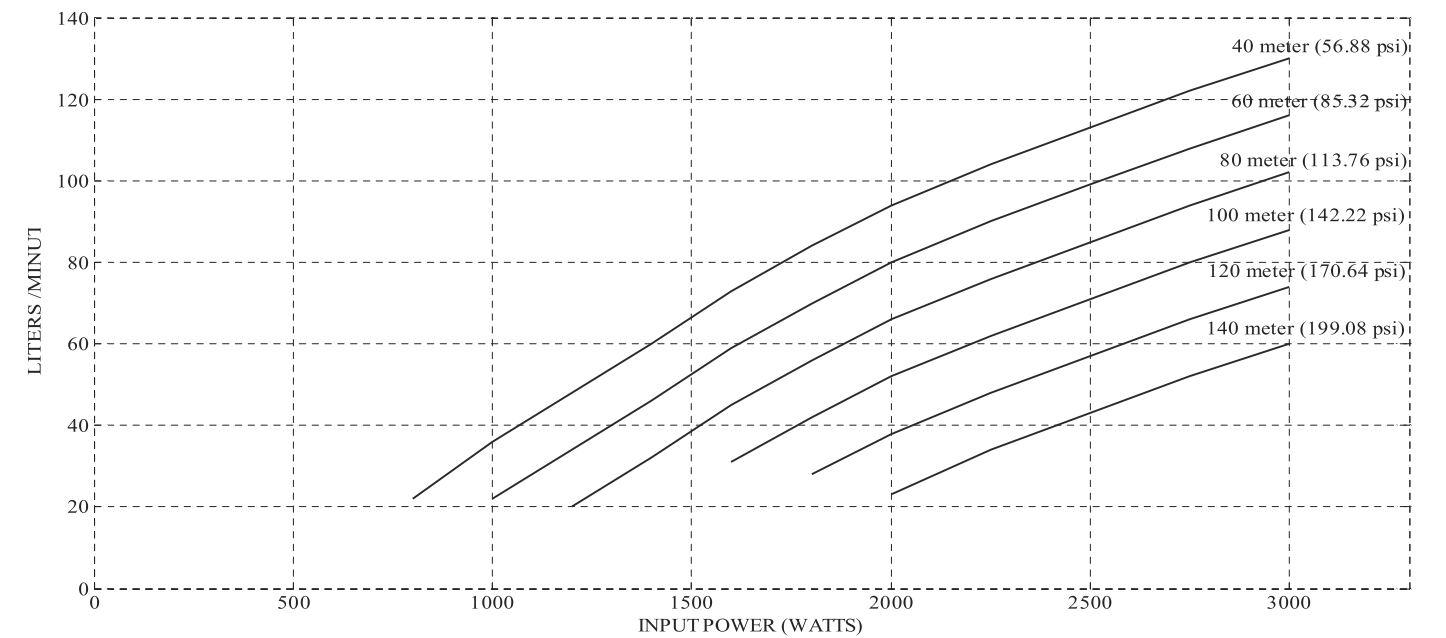

	INPUT POWER (WATTS)										
	3000	2750	2500	2250	2000	1800	1600	1400	1200	1000	800
HEAD (M)	FLOW RATE (LITERS / MINUTE)										
40	130	122	113	104	94	84	73	60	48	36	22
60	116	108	99	90	80	70	59	46	34	22	
80	102	94	85	76	66	56	45	32	20		
100	88	80	71	62	52	42	31				
120	74	66	57	48	38	28					
140	60	52	43	34	23						

**PUMP PERFORMANCE SSP4000 - 30 - 45**

**MOTOR 3 HP**

380 Volt Motor – (6"x6") – BSP 2.5"  
Maximum OD 6" – Material Code 9500000202

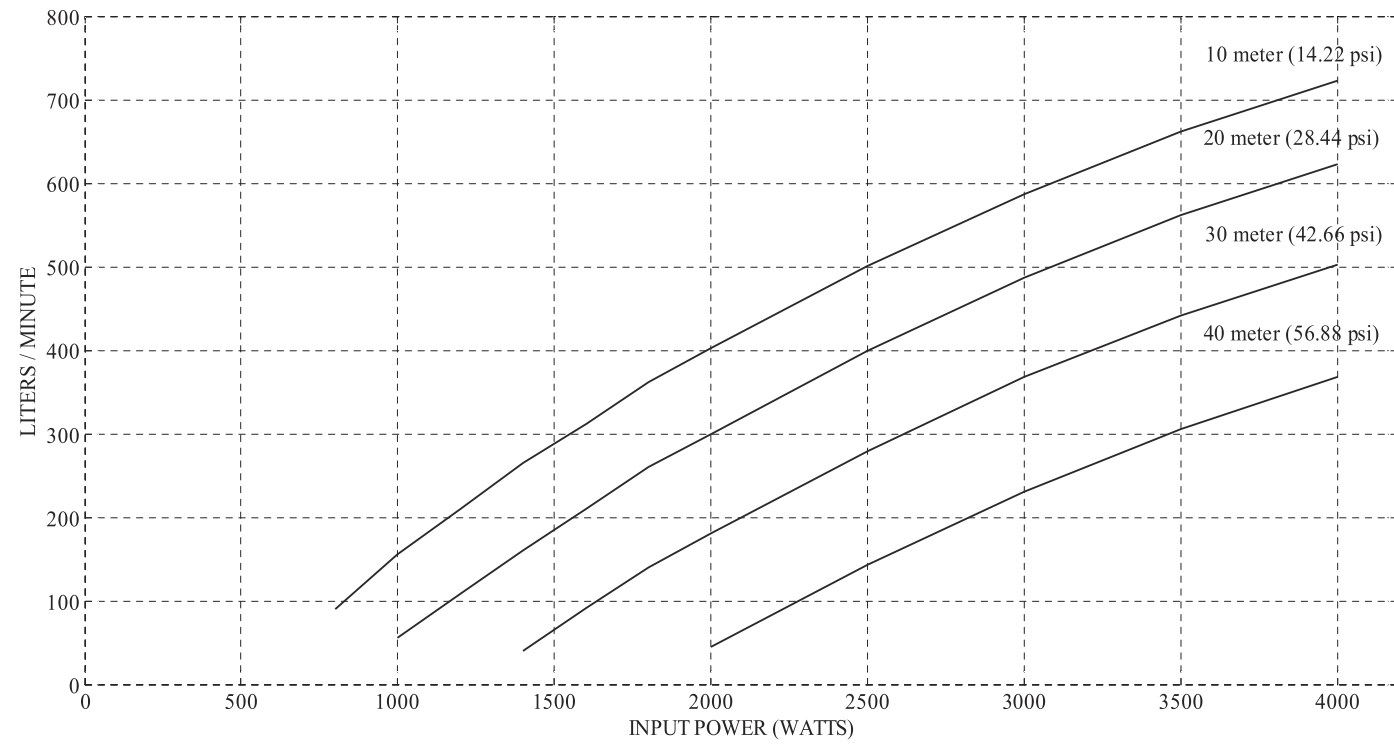

	INPUT POWER (WATTS)										
	4000	3500	3000	2500	2000	1800	1600	1400	1200	1000	800
HEAD (M)	FLOW RATE (LITERS / MINUTE)										
10	722	662	587	501	402	362	311	265	210	155	90
20	622	562	486	400	300	260	210	160	108	56	
30	502	442	368	279	180	140	92	42			
40	368	306	230	143	44						



**PUMP PERFORMANCE SSP4000 - 70 - 15**

**MOTOR 4 HP**

380 Volt Motor – (6"x4") – BSP 2.0"  
Maximum OD 6" – Material Code 9500000073

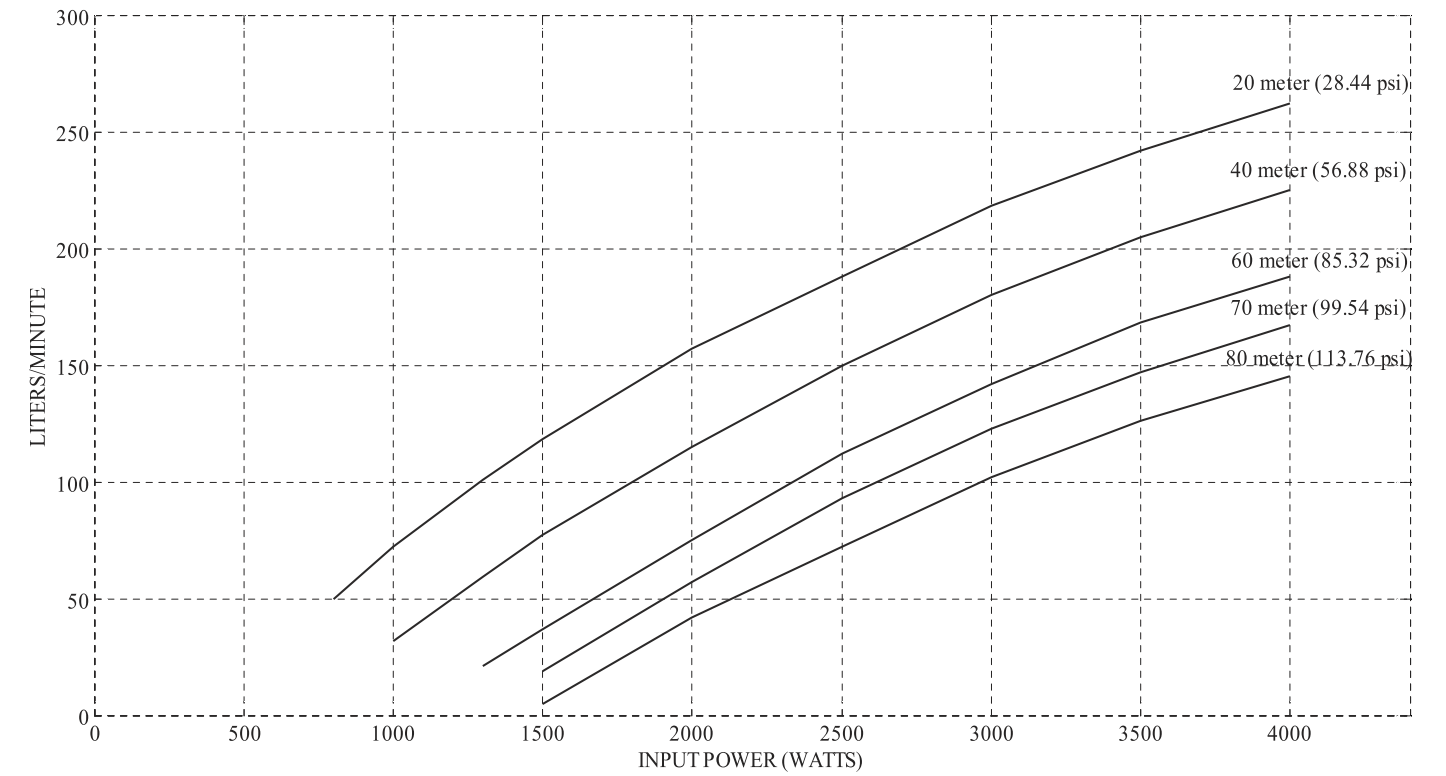

	INPUT POWER (WATTS)									
	4000	3500	3000	2500	2000	1500	1300	1000	800	
HEAD (M)	FLOW RATE (LITERS / MINUTE)									
20	262	242	218	188	157	118	101	72	50	
40	225	205	180	150	115	77	59	32		
60	188	168	142	112	75	37	21			
70	167	147	123	93	57	19				
80	144	126	102	72	42	5				

**PUMP PERFORMANCE SSP4000 - 120 - 8**

**MOTOR 4 HP**

380 Volt Motor – (4"x4") – BSP 1.5"  
 Maximum OD 6" – Material Code 9500000035

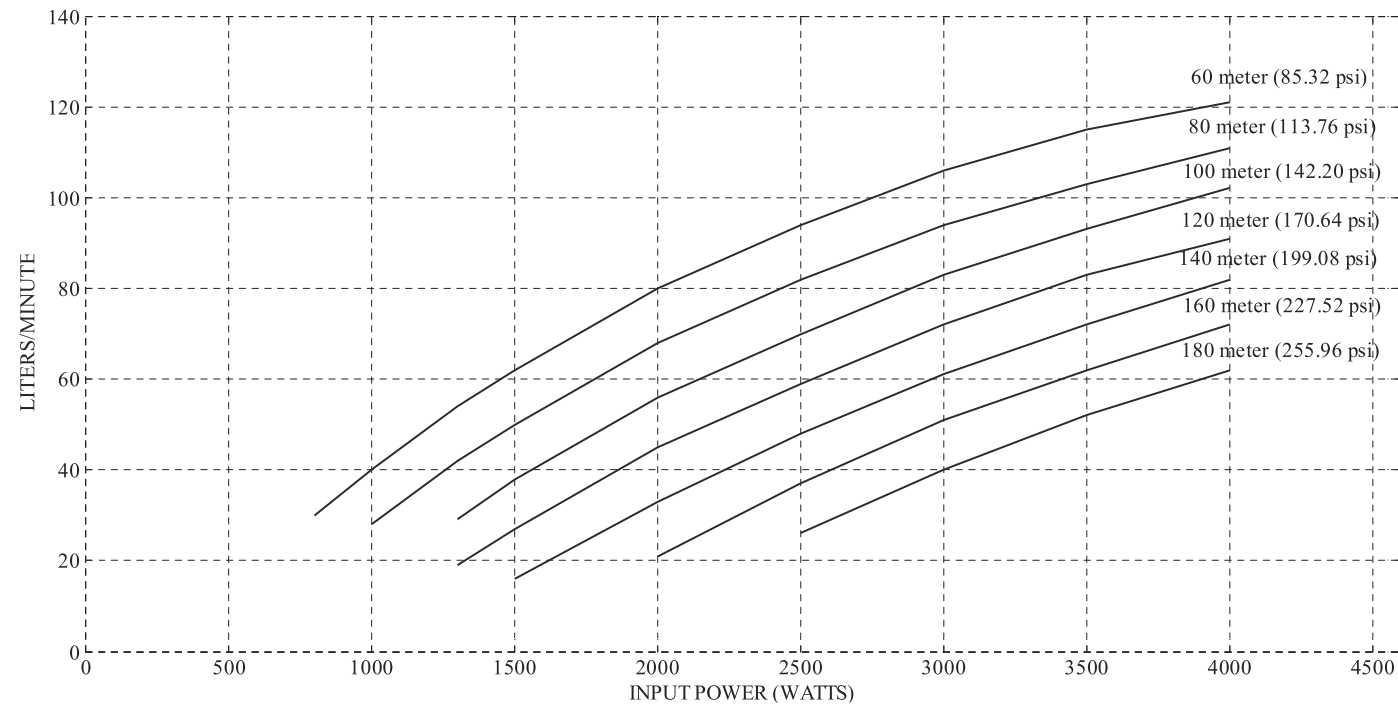

HEAD (M)	INPUT POWER (WATTS)								
	4000	3500	3000	2500	2000	1500	1300	1000	800
60	121	115	106	94	80	62	54	40	30
80	111	103	94	82	68	50	42	28	
100	102	93	83	70	56	38	29		
120	91	83	72	59	45	26	18		
140	82	72	61	48	33	16			
160	72	62	51	37	21				
180	62	52	40	26					



**PUMP PERFORMANCE SSP5000 - 10 - 129**

**MOTOR 5 HP**

380 Volt Motor – (6"x8") – BSP 4"  
 Maximum OD 8" – Material Code 9500000070

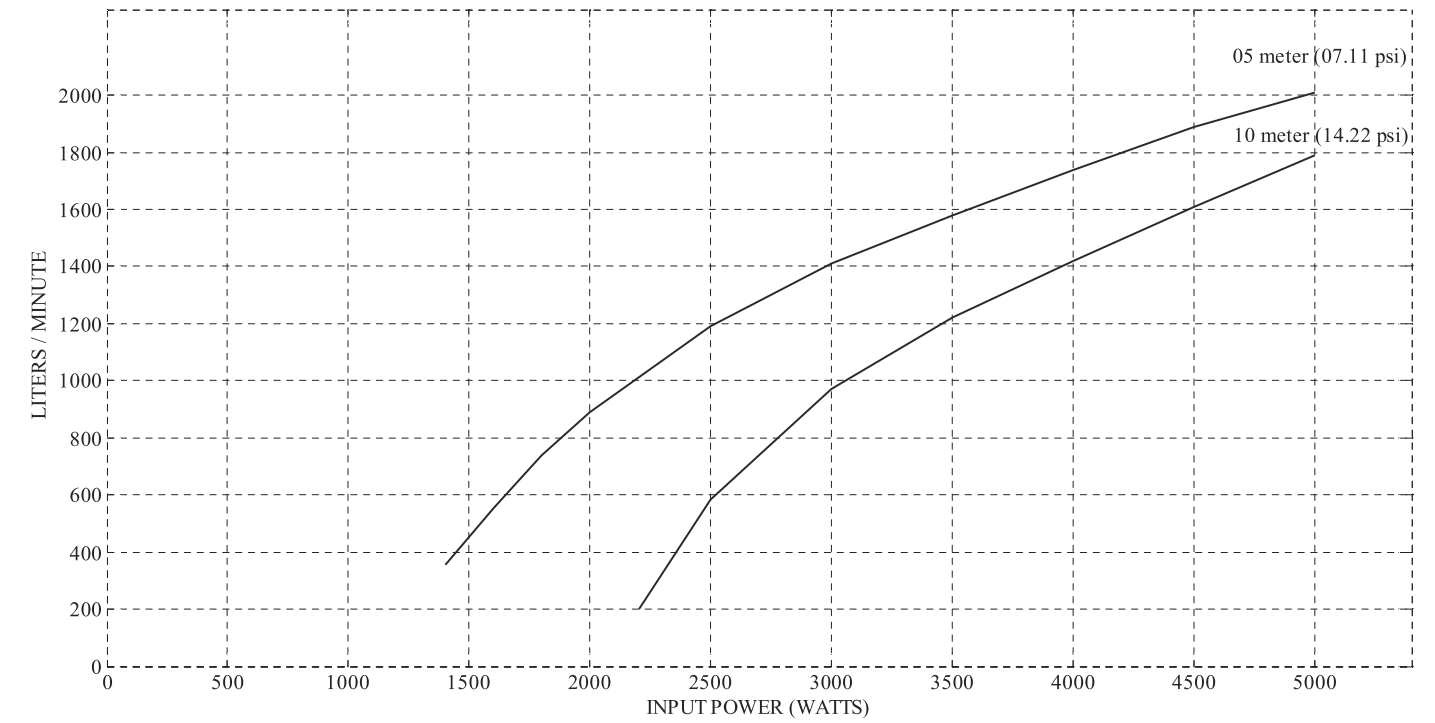

HEAD (M)	INPUT POWER (WATTS)										
	5000	4500	4000	3500	3000	2500	2300	2000	1800	1600	1400
05	2010	1890	1740	1580	1410	1190	1080	890	740	555	355
10	1790	1610	1420	1220	970	585	200				



**PUMP PERFORMANCE SSP5000 - 20 - 64**

**MOTOR 5 HP**

380 Volt Motor – (6"x6") – BSP 3"  
 Maximum OD 6" – Material Code 9500000031

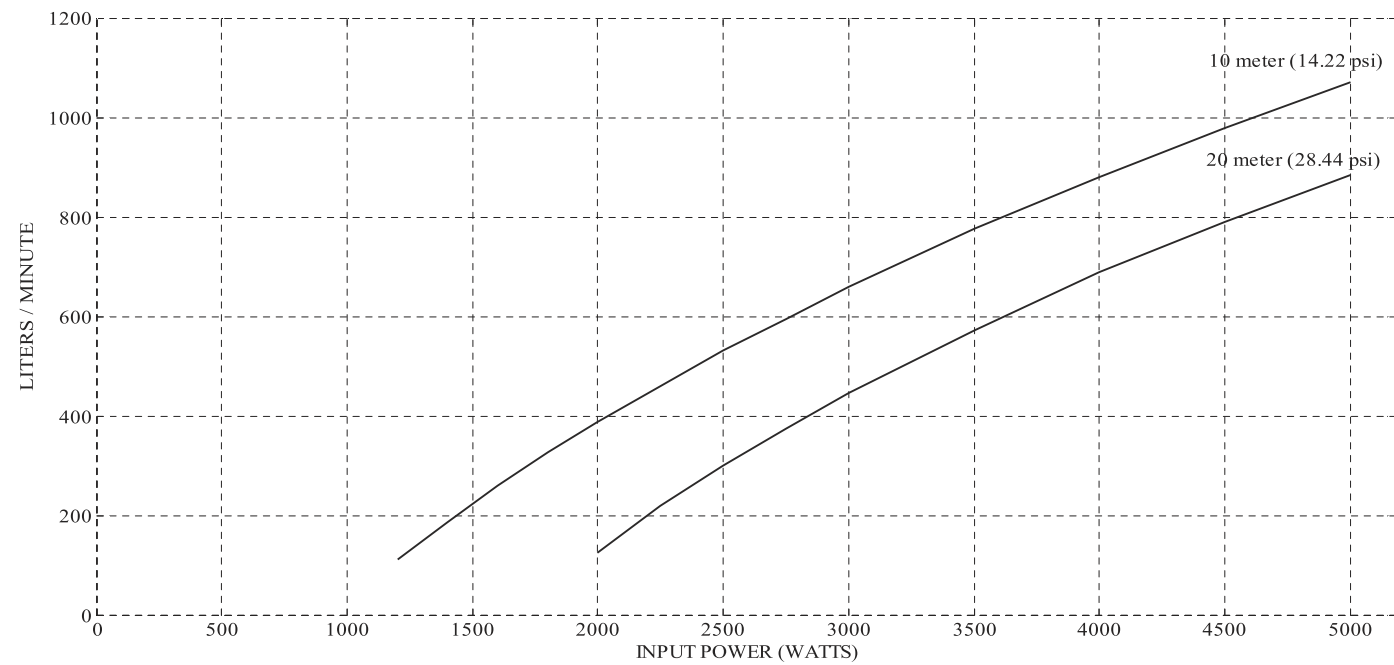

	INPUT POWER (WATTS)												
	5000	4500	4000	3500	3000	2750	2500	2250	2000	1800	1600	1400	1200
HEAD (M)	FLOW RATE (LITERS / MINUTE)												
10	1070	979	880	776	660	595	531	460	388	326	260	185	112
20	885	790	688	572	447	375	300	218	124				



**PUMP PERFORMANCE SSP5000 - 30 - 39**

**MOTOR 5 HP**

380 Volt Motor – (6"x6") – BSP 2.5"  
 Maximum OD 6" – Material Code 9500000104

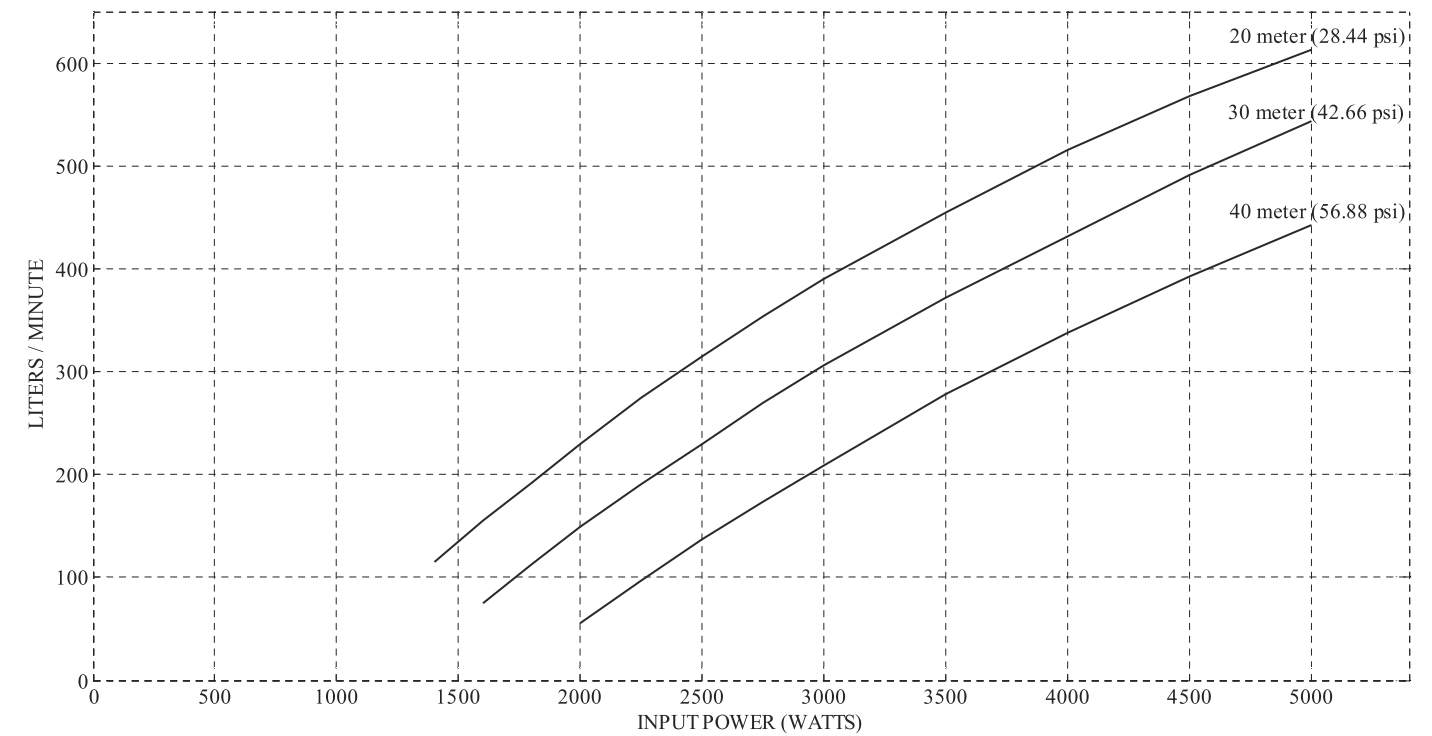

	INPUT POWER (WATTS)											
	5000	4500	4000	3500	3000	2750	2500	2250	2000	1800	1600	1400
HEAD (M)	FLOW RATE (LITERS / MINUTE)											
20	613	568	515	455	390	354	315	275	229	192	155	115
30	543	491	432	372	306	270	230	191	149	112	75	
40	442	392	338	278	209	174	137	97	55			

**PUMP PERFORMANCE SSP5000 - 50 - 24**

**MOTOR 5 HP**

380 Volt Motor – (6"x6") – BSP 2"  
 Maximum OD 6" – Material Code 9500000010

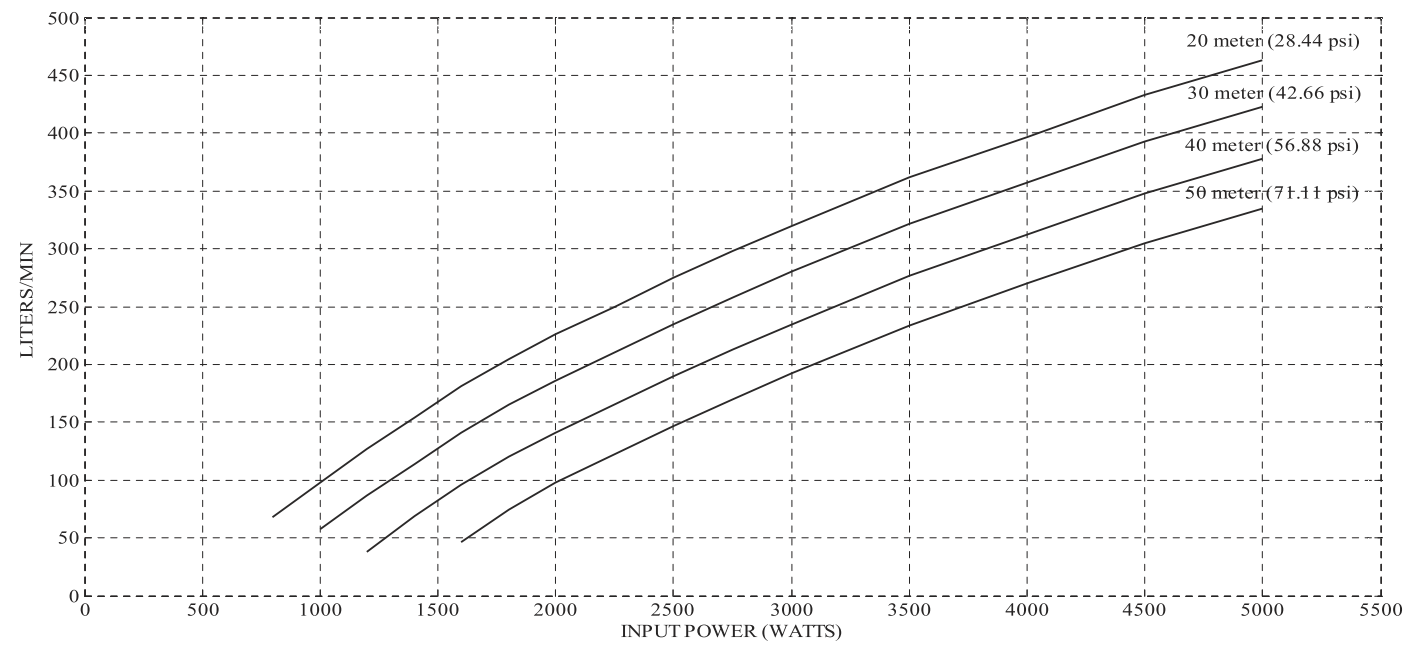

HEAD (M)	INPUT POWER (WATTS)											
	5000	4500	4000	3500	3000	2750	2500	2250	2000	1600	1200	800
20	463	433	397	362	320	298	275	250	226	181	127	68
30	423	393	357	322	280	258	235	210	186	141	87	
40	378	348	312	277	235	213	190	165	141	96	38	
50	335	305	270	234	192	170	147	122	98	46		



**PUMP PERFORMANCE SSP5000 - 70 - 18**

**MOTOR 5 HP**

380 Volt Motor – (6"x6") – BSP 2"  
 Maximum OD 6" – Material Code 9500000011

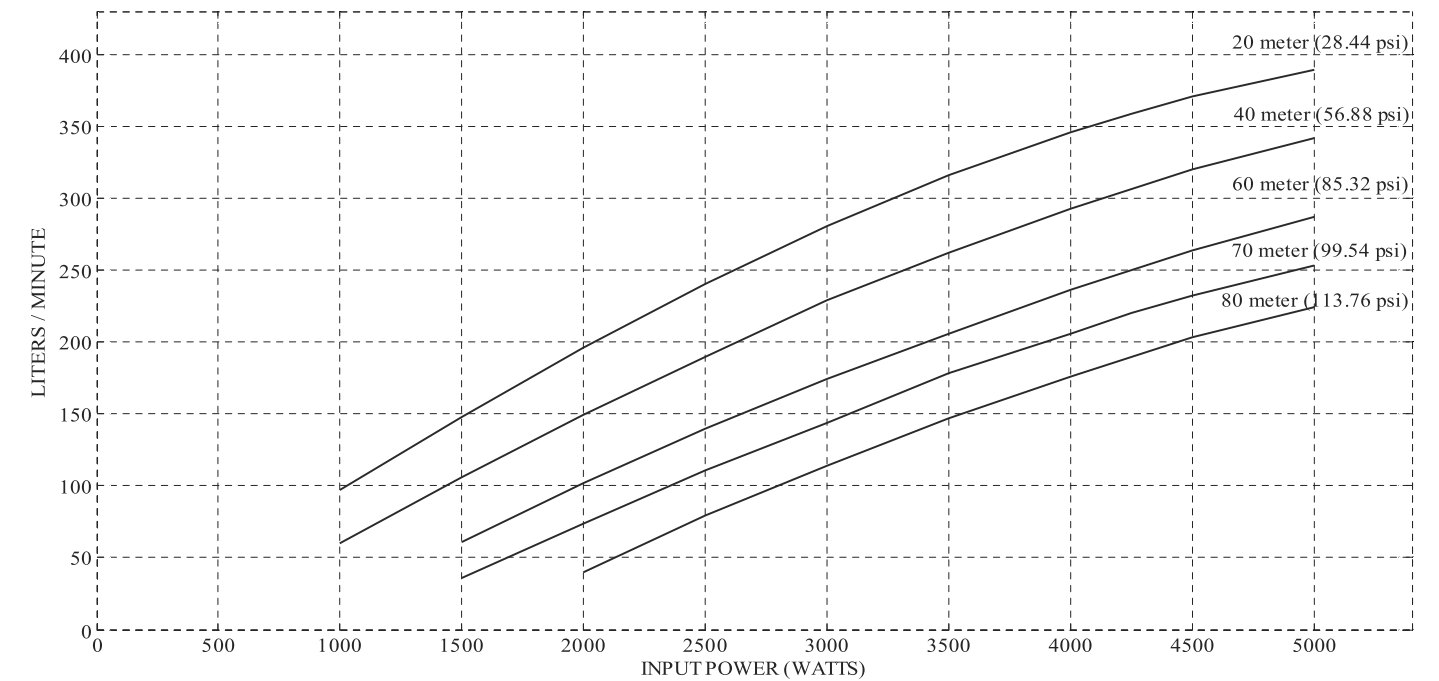

HEAD (M)	INPUT POWER (WATTS)									
	5000	4500	4250	4000	3500	3000	2500	2000	1500	1000
20	389	371	359	346	316	281	240	196	148	97
40	342	320	306	293	262	229	190	149	106	60
60	287	264	250	236	206	174	140	102	61	
70	253	232	220	206	178	144	111	74	36	
80	224	203	190	176	147	114	79	40		

**PUMP PERFORMANCE SSP5000 - 100 - 11**

**MOTOR 5 HP**

380 Volt Motor – (6"x4") – BSP 2"  
 Maximum OD 6" – Material Code 9500000012

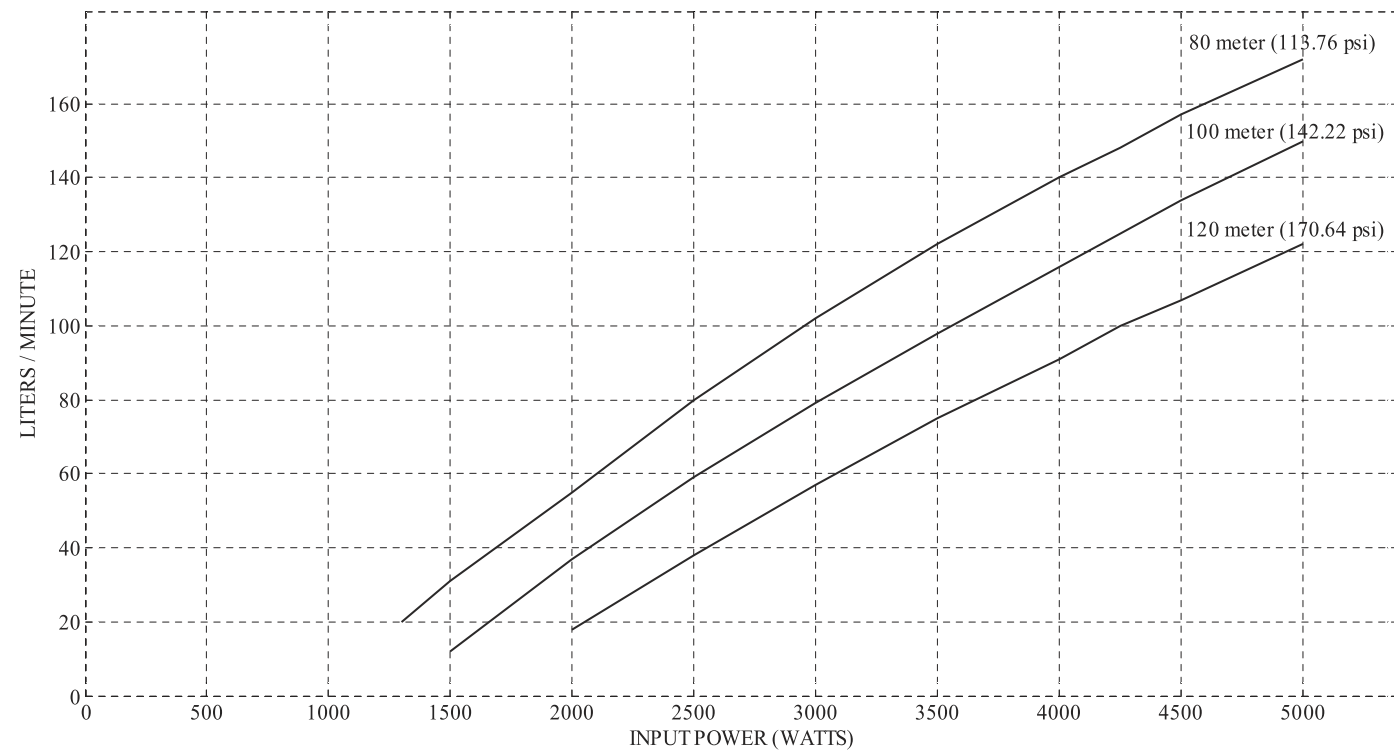

	INPUT POWER (WATTS)									
	5000	4500	4250	4000	3500	3000	2500	2000	1500	1300
HEAD (M)	FLOW RATE (LITERS / MINUTE)									
80	172	157	148	140	122	102	80	55	31	20
100	150	134	125	116	98	79	59	37	12	
120	122	107	100	91	75	57	38	18		



**PUMP PERFORMANCE SSP5000 - 220 - 4**

**MOTOR 5 HP**

380 Volt Motor – (6"x4") – BSP 1.25"  
 Maximum OD 6" – Material Code 9500000203

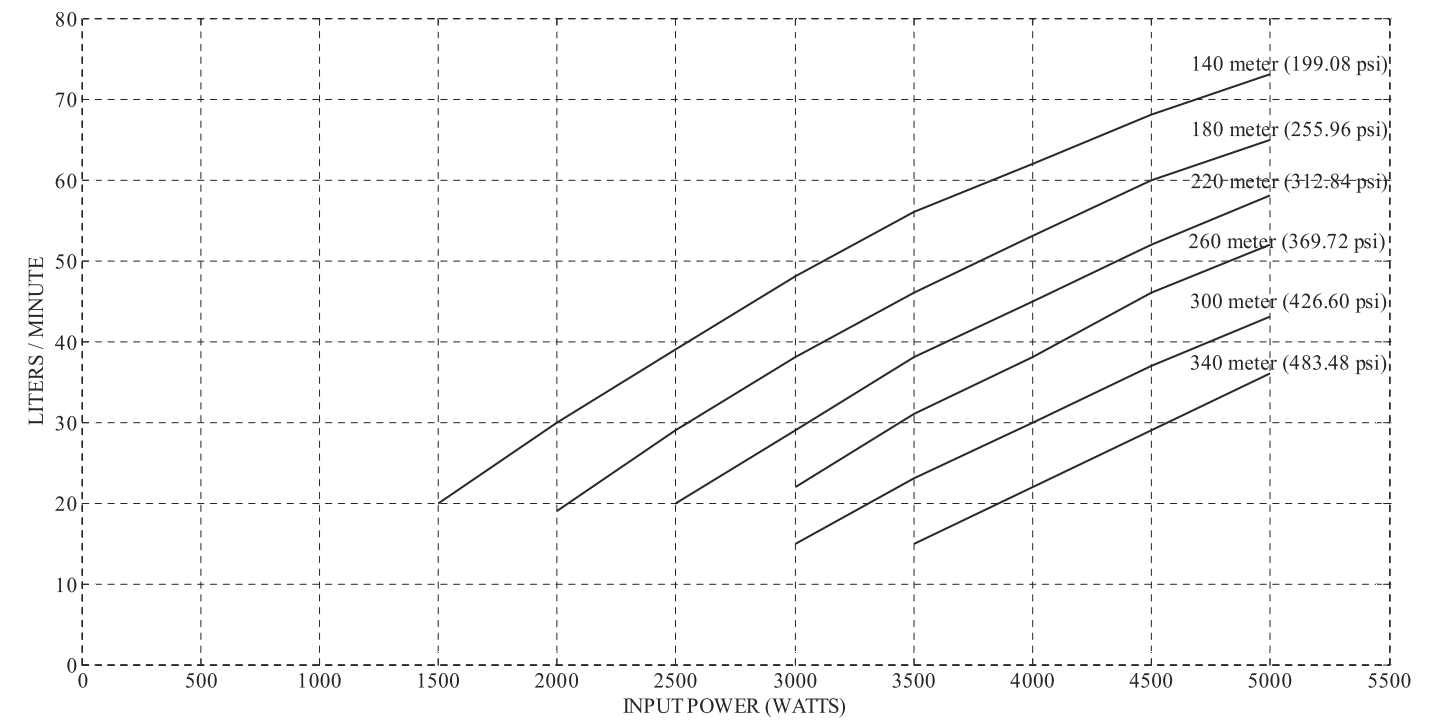

	INPUT POWER (WATTS)							
	5000	4500	4000	3500	3000	2500	2000	1500
HEAD (M)	FLOW RATE (LITERS / MINUTE)							
140	73	68	62	56	48	39	30	20
180	65	60	53	45	38	29	20	
220	58	52	45	38	29	20		
260	52	46	38	31	22			
300	43	37	30	23	15			
340	36	29	22	15				

**PUMP PERFORMANCE SSP6750 - 70 - 18 / 50 - 21**

**MOTOR 7.5 HP**

380 Volt Motor – (6"x6") – BSP 2.0"  
Maximum OD 6" – Material Code 9500000224

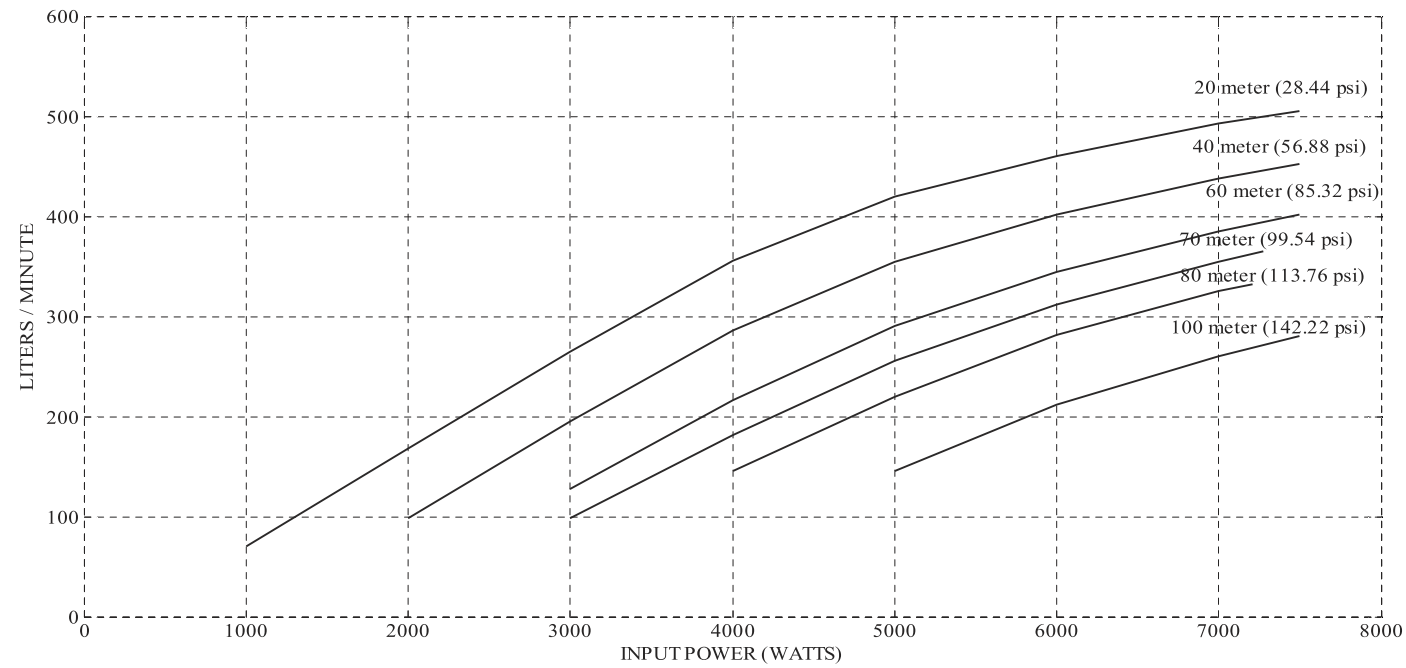

	INPUT POWER (WATTS)							
	7500	7000	6000	5000	4000	3000	2000	1000
HEAD (M)	FLOW RATE (LITERS / MINUTE)							
20	505	490	460	420	356	265	168	70
40	452	435	405	355	286	195	98	
60	402	385	350	295	216	125		
70	375	351	312	257	182	98		
80	343	325	281	220	145			
100	280	260	212	145				



**PUMP PERFORMANCE SSP7500 - 100 - 12**

**MOTOR 7.5 HP**

380 Volt Motor – (6"x6") – BSP 2"  
Maximum OD 6" – Material Code 9500000078

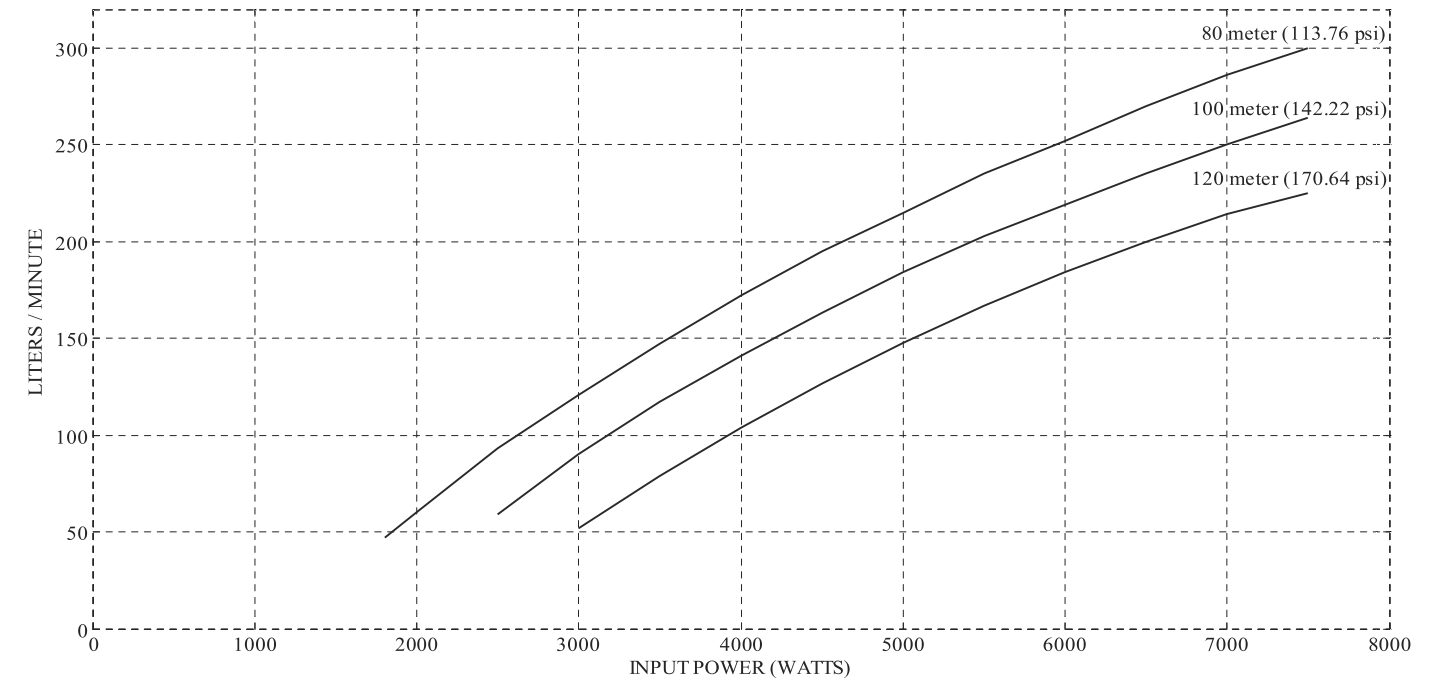

	INPUT POWER (WATTS)												
	7500	7000	6500	6000	5500	5000	4500	4000	3500	3000	2500	2000	1800
HEAD (M)	FLOW RATE (LITERS / MINUTE)												
80	300	286	270	252	235	215	195	172	147	121	93	60	47
100	264	250	235	219	203	184	163	141	117	90	59		
120	225	214	200	184	167	148	127	104	79	52			

**PUMP PERFORMANCE SSP9000 - 130 - 10**

**MOTOR 10 HP**

380 Volt Motor – (6"x6") – BSP 2"  
 Maximum OD 6" – Material Code 9500000112

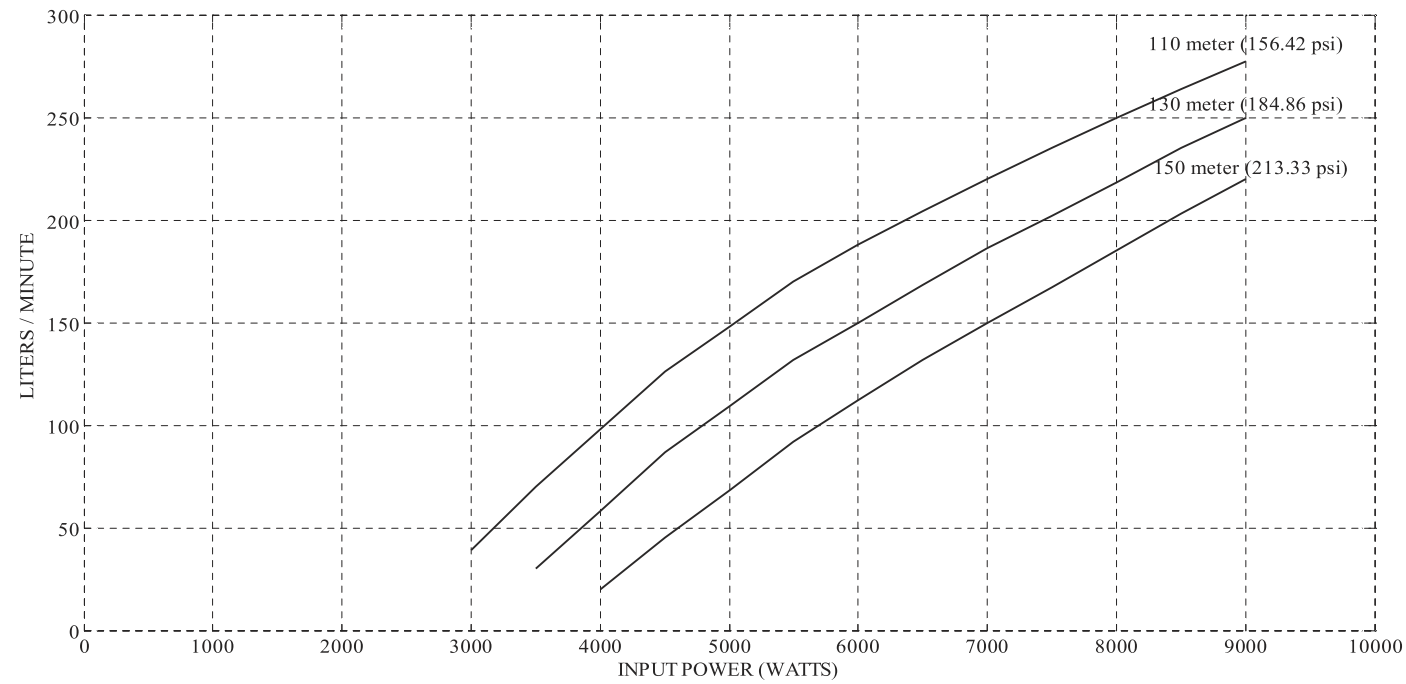

	INPUT POWER (WATTS)												
	9000	8500	8000	7500	7000	6500	6000	5500	5000	4500	4000	3500	3000
HEAD (M)	FLOW RATE (LITERS / MINUTE)												
110	277	264	250	235	220	204	188	170	148	126	98	70	39
130	250	235	218	202	186	168	150	132	109	87	58	30	
150	220	203	185	167	150	132	112	92	68	45	20		



**PUMP PERFORMANCE SSP10000 - 20 - 57**

**MOTOR 10 HP**

380 Volt Motor – (6"x8") – BSP 4.0"  
 Maximum OD 8" – Material Code 9500000084

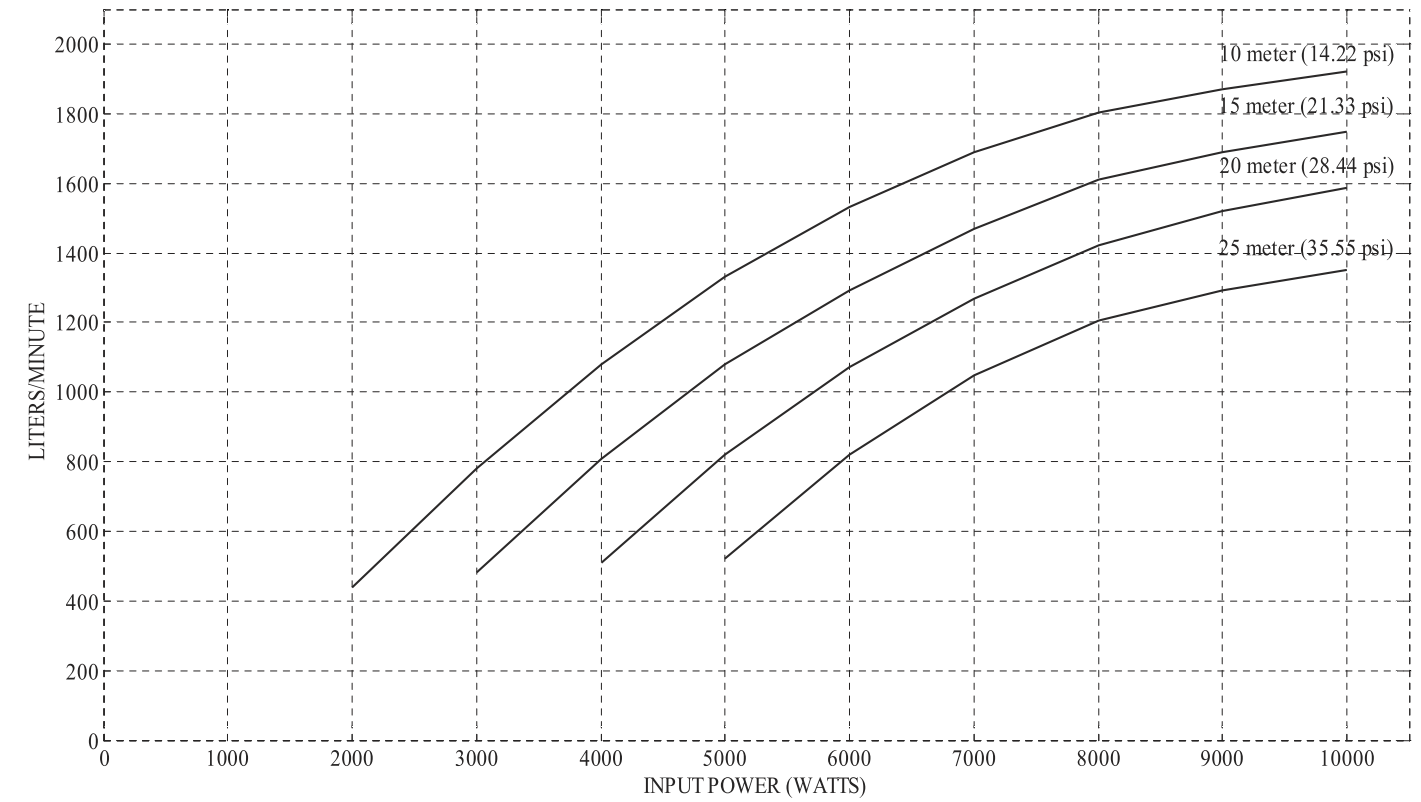

	INPUT POWER (WATTS)									
	10000	9000	8000	7000	6000	5000	4000	3000	2000	
HEAD (M)	FLOW RATE (LITERS / MINUTE)									
10	1920	1870	1805	1700	1530	1330	1080	780	440	
15	1748	1690	1610	1480	1290	1080	810	480		
20	1585	1520	1420	1280	1070	820	510			
25	1350	1290	1207	1060	820	520				

**PUMP PERFORMANCE SSP10000 - 40 - 31**

**MOTOR 10 HP**

380 Volt Motor – (6"x6") – BSP 3.0"  
Maximum OD 6" – Material Code 9500000376

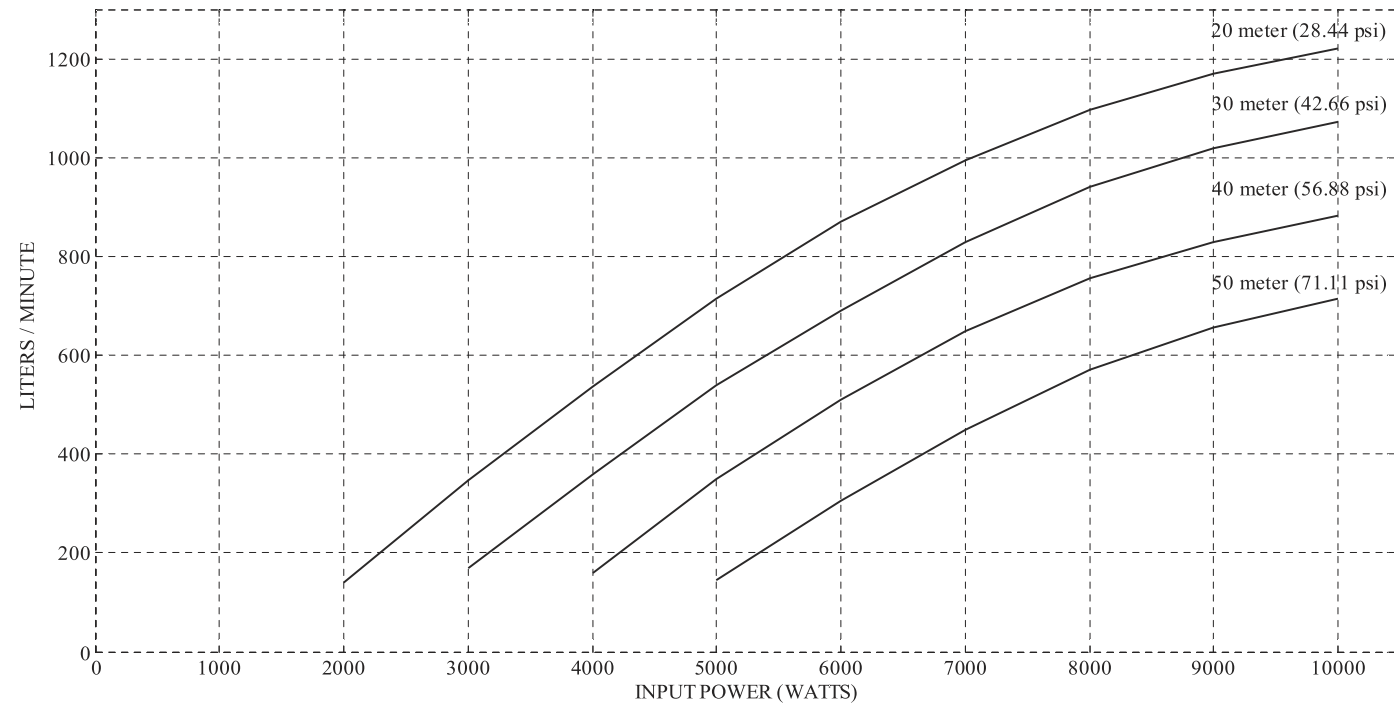

	INPUT POWER (WATTS)								
	10000	9000	8000	7000	6000	5000	4000	3000	2000
HEAD (M)	FLOW RATE (LITERS / MINUTE)								
20	1222	1170	1097	995	870	715	538	348	140
30	1072	1020	941	829	690	539	360	170	
40	882	830	755	650	540	350	160		
50	714	657	570	450	305	145			



**PUMP PERFORMANCE SSP9000 - 50 - 21**

**MOTOR 10 HP**

380 Volt Motor – (6"x6") – BSP 2.5"  
Maximum OD 6" – Material Code 9500000077

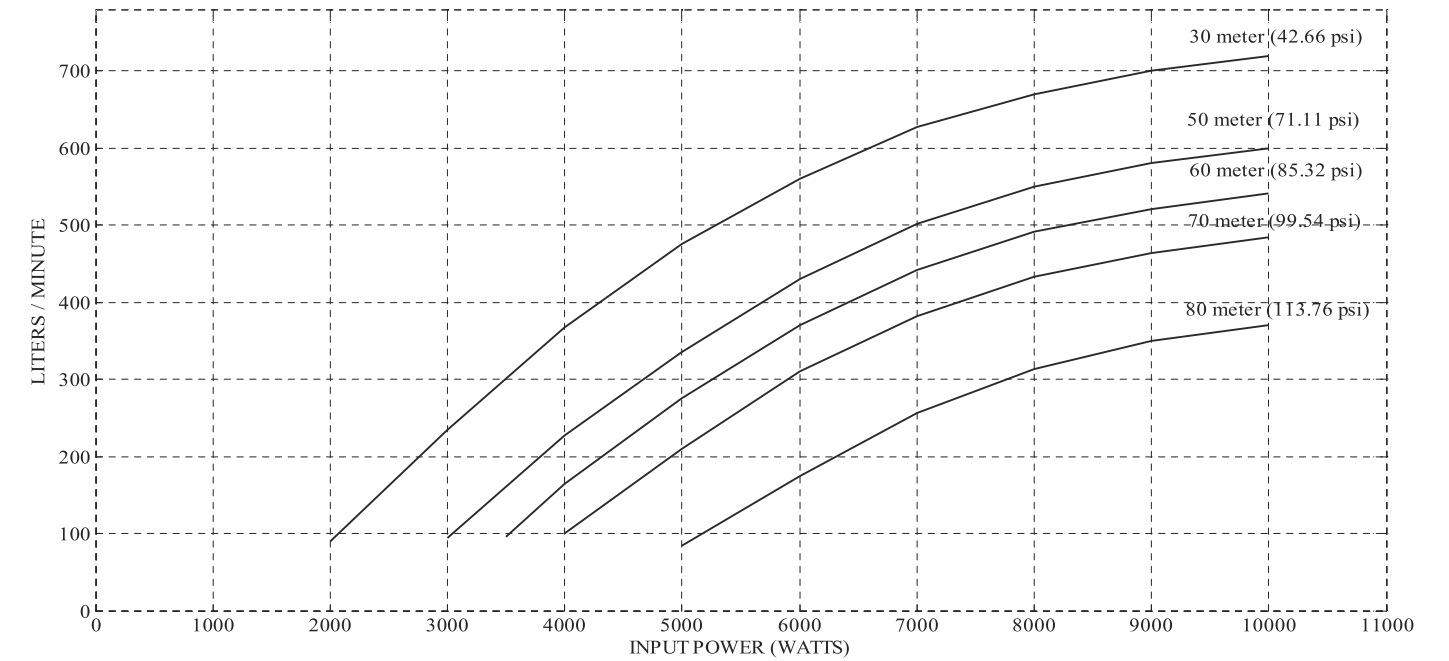

	INPUT POWER (WATTS)								
	10000	9000	8000	7000	6000	5000	4000	3000	2000
HEAD (M)	FLOW RATE (LITERS / MINUTE)								
30	720	700	670	627	560	475	367	235	90
50	600	580	550	507	430	335	227	94	
60	541	521	491	442	371	276	165		
70	484	464	433	382	310	210	100		
80	370	350	314	257	175	84			

**PUMP PERFORMANCE SSP10000 - 80 - 14**

**MOTOR 10 HP**

380 Volt Motor – (6"x6") – BSP 2.0"  
 Maximum OD 6" – Material Code 9500000072

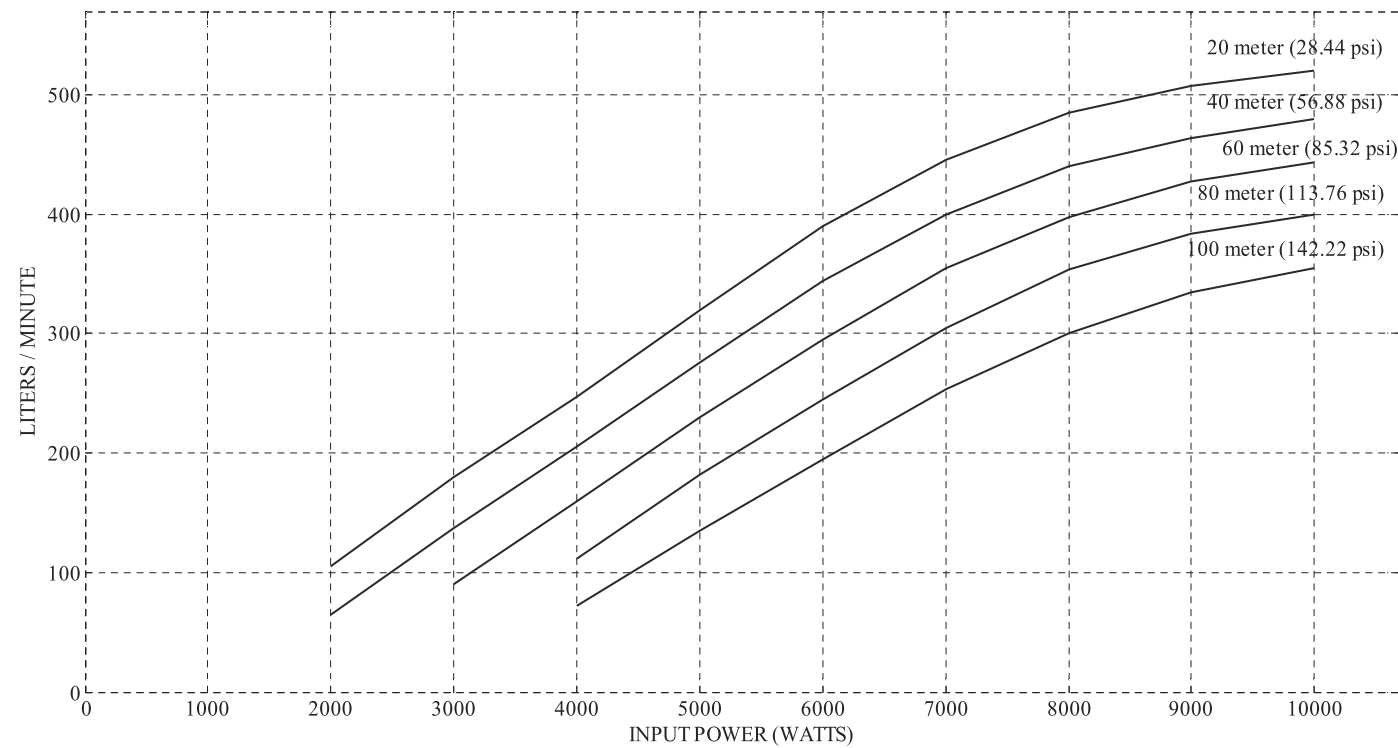

	INPUT POWER (WATTS)								
	10000	9000	8000	7000	6000	5000	4000	3000	2000
HEAD (M)	FLOW RATE (LITERS / MINUTE)								
20	520	508	485	446	390	320	247	180	105
40	480	464	440	400	344	276	205	137	65
60	444	428	398	355	295	230	160	90	
80	400	384	354	305	245	182	112		
100	355	335	300	254	195	135	72		



**PUMP PERFORMANCE SSP10000 - 140 - 9**

**MOTOR 10 HP**

380 Volt Motor – (6"x6") – BSP 2"  
 Maximum OD 6" – Material Code 9500000096

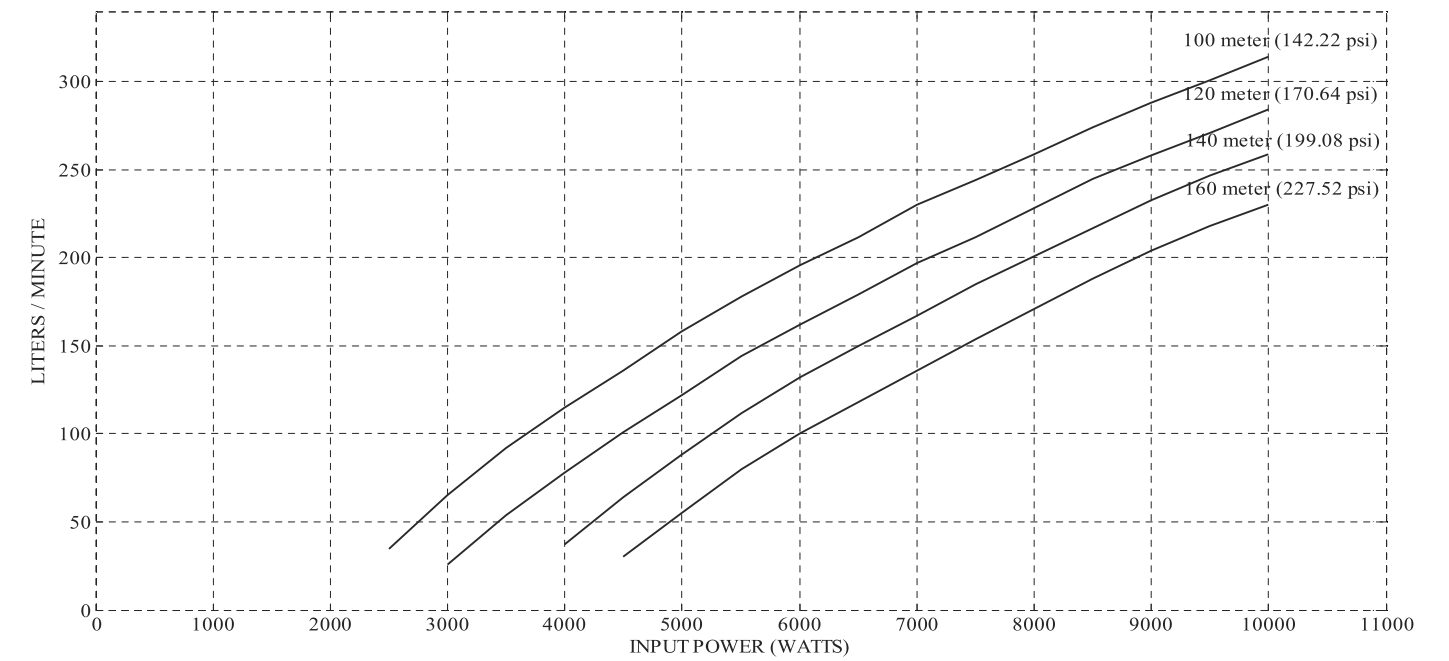

	INPUT POWER (KW)															
	10	9.5	9	8.5	8	7.5	7	6.5	6	5.5	5	4.5	4	3.5	3	2.5
HEAD (M)	FLOW RATE (LITERS / MINUTE)															
100	314	301	288	274	259	244	230	212	196	178	158	136	115	92	65	35
120	284	271	258	245	228	212	197	179	162	144	122	101	78	54	26	
140	259	247	233	217	201	185	167	150	132	112	88	64	37			
160	230	218	204	188	171	154	136	118	100	80	55	30				

**PUMP PERFORMANCE SSP12500 - 30 - 41**

**MOTOR 12.5 HP**

380 Volt Motor – (6"x8") – BSP 4.0"  
 Maximum OD 8" – Material Code 9500000086

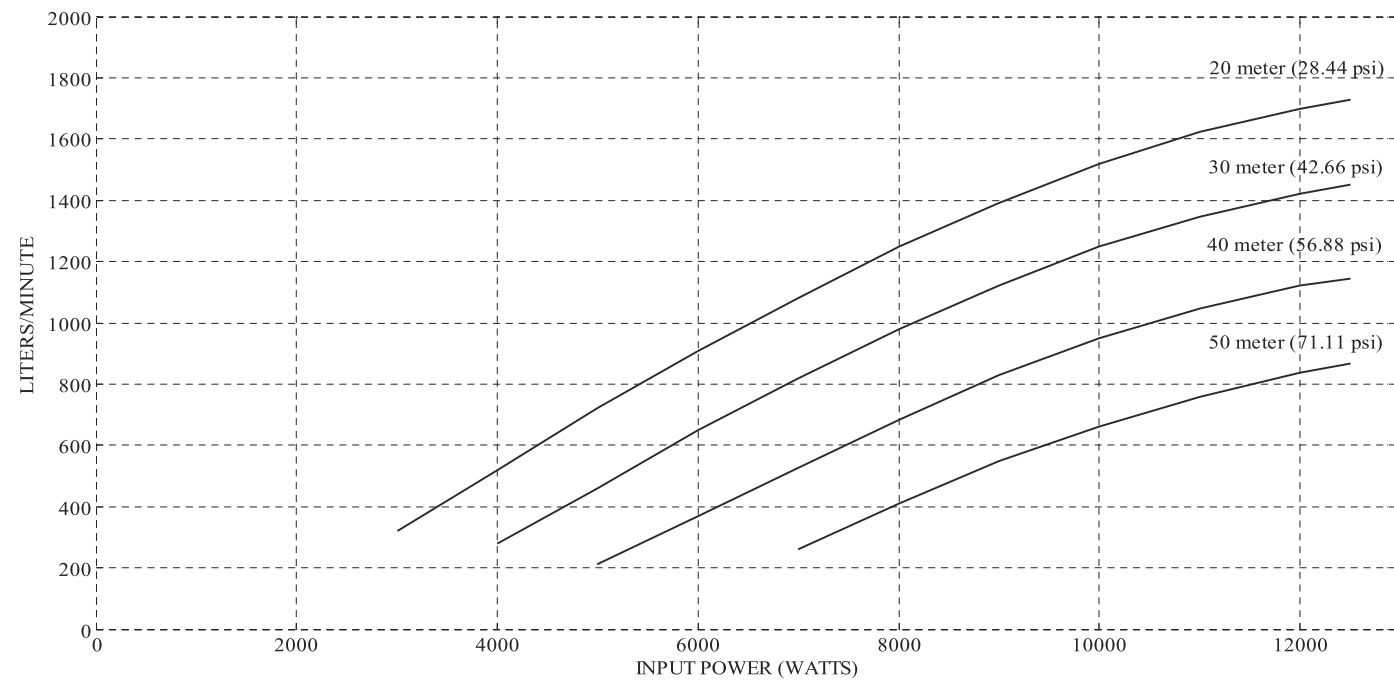

	INPUT POWER (WATTS)										
	12500	12000	11000	10000	9000	8000	7000	6000	5000	4000	3000
HEAD (M)	FLOW RATE (LITERS / MINUTE)										
20	1730	1700	1622	1520	1390	1250	1080	910	720	520	320
30	1450	1420	1345	1250	1120	980	820	650	460	280	
40	1146	1122	1045	948	828	685	525	370	210		
50	868	838	760	660	550	410	260				



**PUMP PERFORMANCE SSP15000 - 60 - 22**

**MOTOR 15 HP**

380 Volt Motor – (6"x6") – BSP 3.0"  
 Maximum OD 6" – Material Code 9500000082

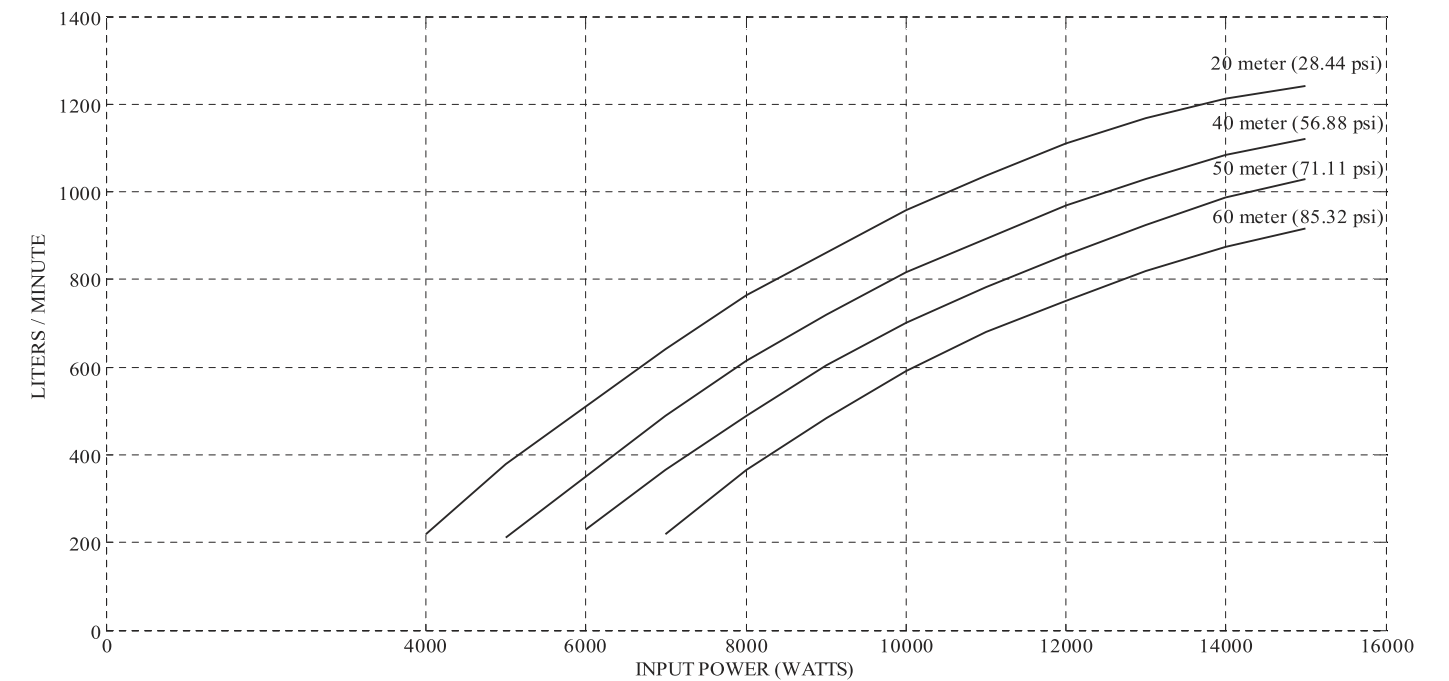

	INPUT POWER (WATTS)											
	15000	14000	13000	12000	11000	10000	9000	8000	7000	6000	5000	4000
HEAD (M)	FLOW RATE (LITERS / MINUTE)											
20	1241	1212	1168	1110	1037	957	860	765	640	510	380	220
40	1122	1083	1030	968	892	817	720	615	490	380	210	
50	1028	988	925	855	782	702	605	490	365	230		
60	917	875	820	750	680	590	485	365	220			



**PUMP PERFORMANCE SSP15000 - 100 - 13**

**MOTOR 15 HP**

380 Volt Motor – (6"x6") – BSP 2.5"  
 Maximum OD 6" – Material Code 9500000102

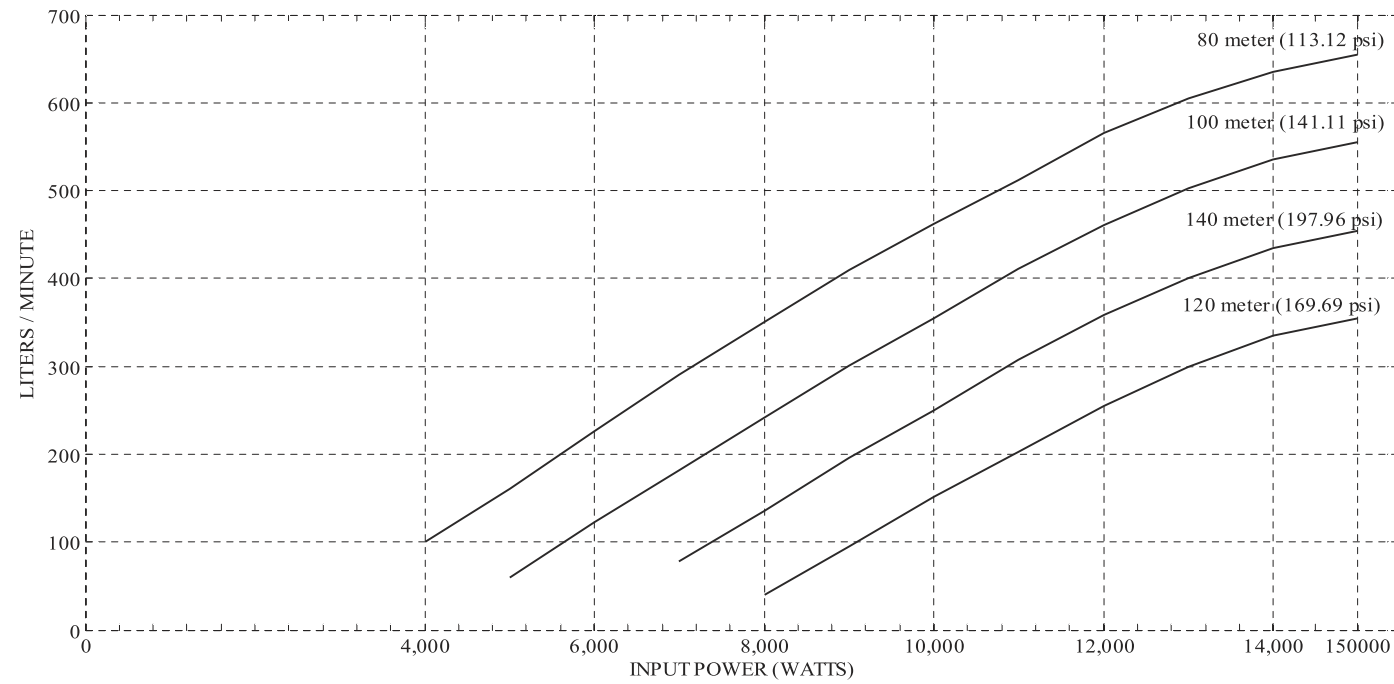

	INPUT POWER (WATTS)											
	15000	14000	13000	12000	11000	10000	9000	8000	7000	6000	5000	4000
HEAD (M)	FLOW RATE (LITERS / MINUTE)											
80	655	635	605	565	512	462	409	351	291	226	161	100
100	555	535	503	461	411	354	301	242	181	122	60	
120	454	434	401	359	307	250	196	136	78			
140	354	335	299	255	203	151	95	40				



**PUMP PERFORMANCE SSP20000 - 80 - 16**

**MOTOR 20 HP**

380 Volt Motor – (6"x6") – BSP 3.0"  
 Maximum OD 6" – Material Code 9500000083

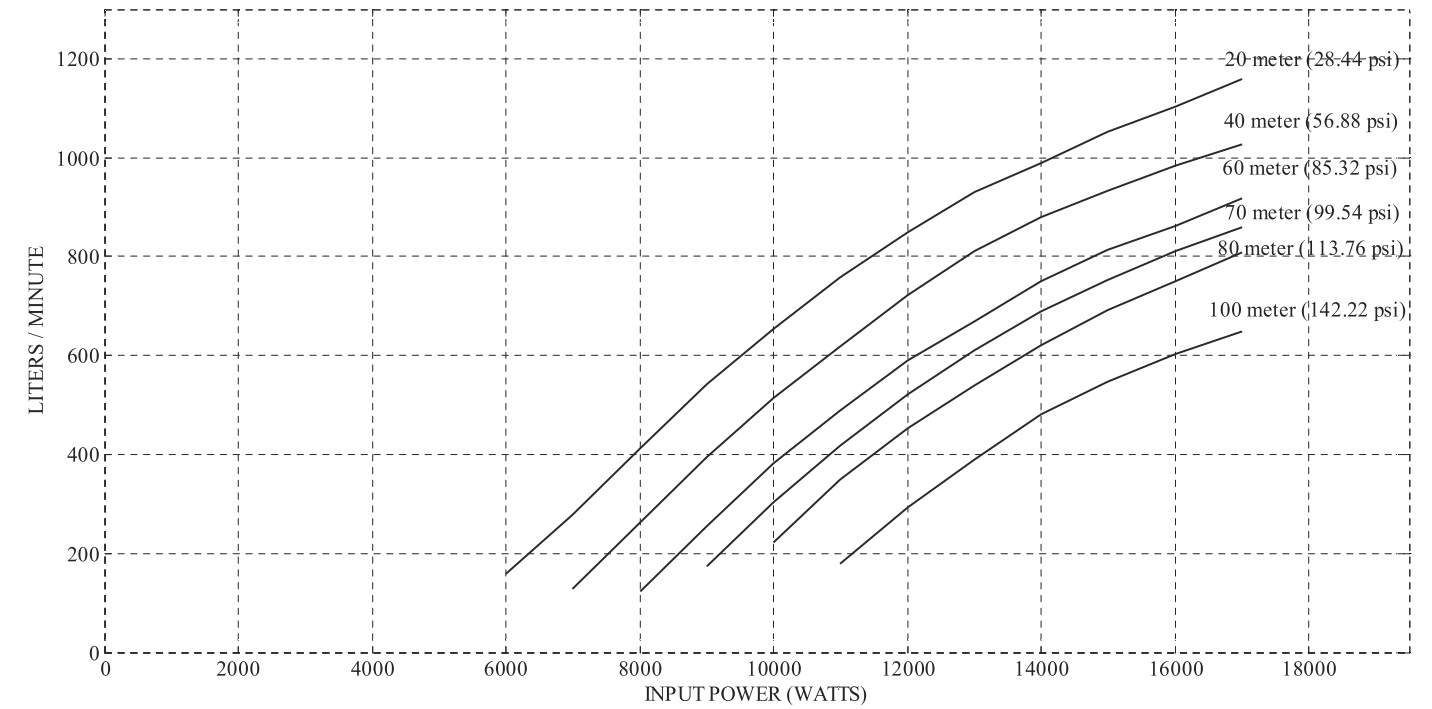

	INPUT POWER (WATTS)											
	17000	16000	15000	14000	13000	12000	11000	10000	9000	8000	7000	6000
HEAD (M)	FLOW RATE (LITERS / MINUTE)											
20	1158	1103	1053	990	930	850	758	653	543	413	278	158
40	1028	983	933	880	810	723	618	513	395	263	128	
60	918	863	813	750	670	590	488	383	255	123		
70	859	810	753	690	610	523	418	303	175			
80	808	751	691	620	540	453	348	223				
100	648	603	548	480	390	293	178					

## PUMP PERFORMANCE SSP20000 - 120 - 11

### MOTOR 20 HP

380 Volt Motor – (6"x6") – BSP 2.50"

Maximum OD 6" – Material Code 9500000103

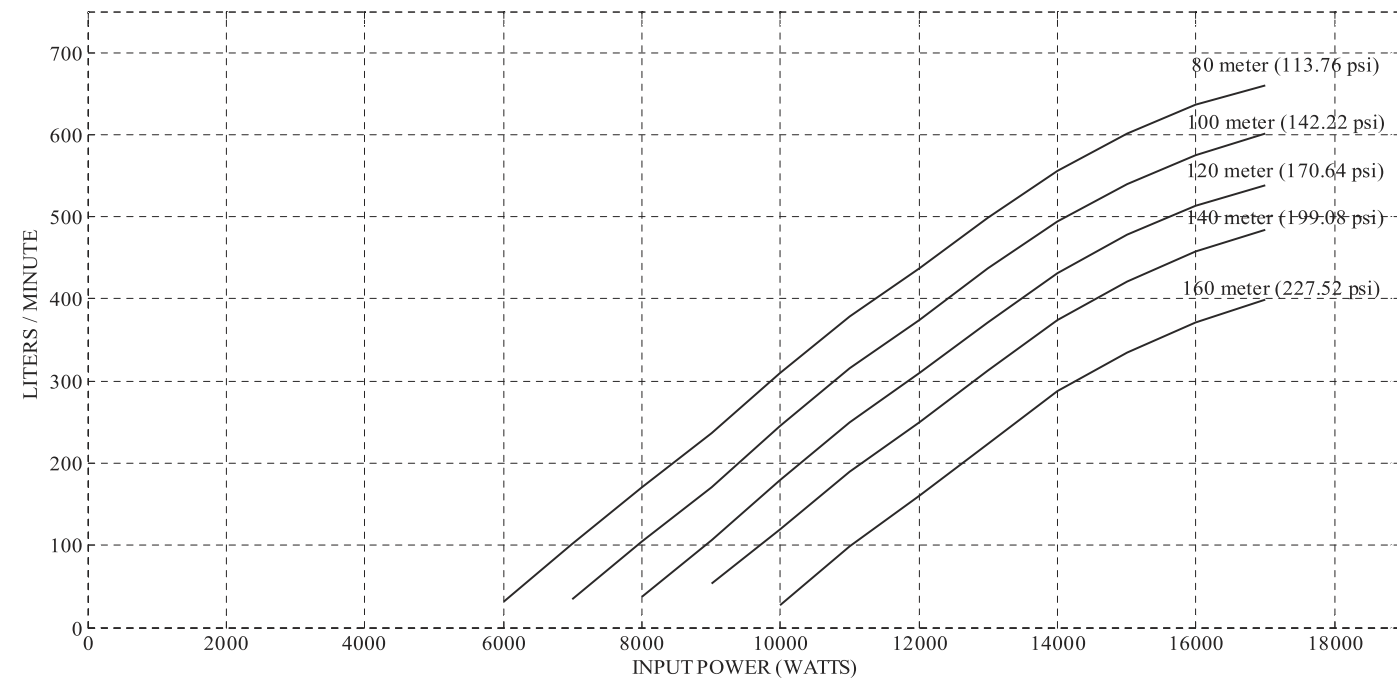

HEAD (M)	INPUT POWER (WATTS)											
	17000	16000	15000	14000	13000	12000	11000	10000	9000	8000	7000	6000
FLOW RATE (LITERS / MINUTE)												
80	660	636	601	556	499	437	379	310	236	171	102	32
100	601	575	540	494	437	375	315	245	171	105	35	
120	539	514	478	432	372	310	250	180	106	38		
140	484	458	421	375	313	250	190	119	54			
160	399	371	334	288	223	161	99	27				

## SOLAR MONOBLOCK PUMP



### SMP SERIES



**PUMP PERFORMANCE SMP1200 - 20 - 30**

**MOTOR 1 HP**

120 Volt Motor  
Material Code 9000016532

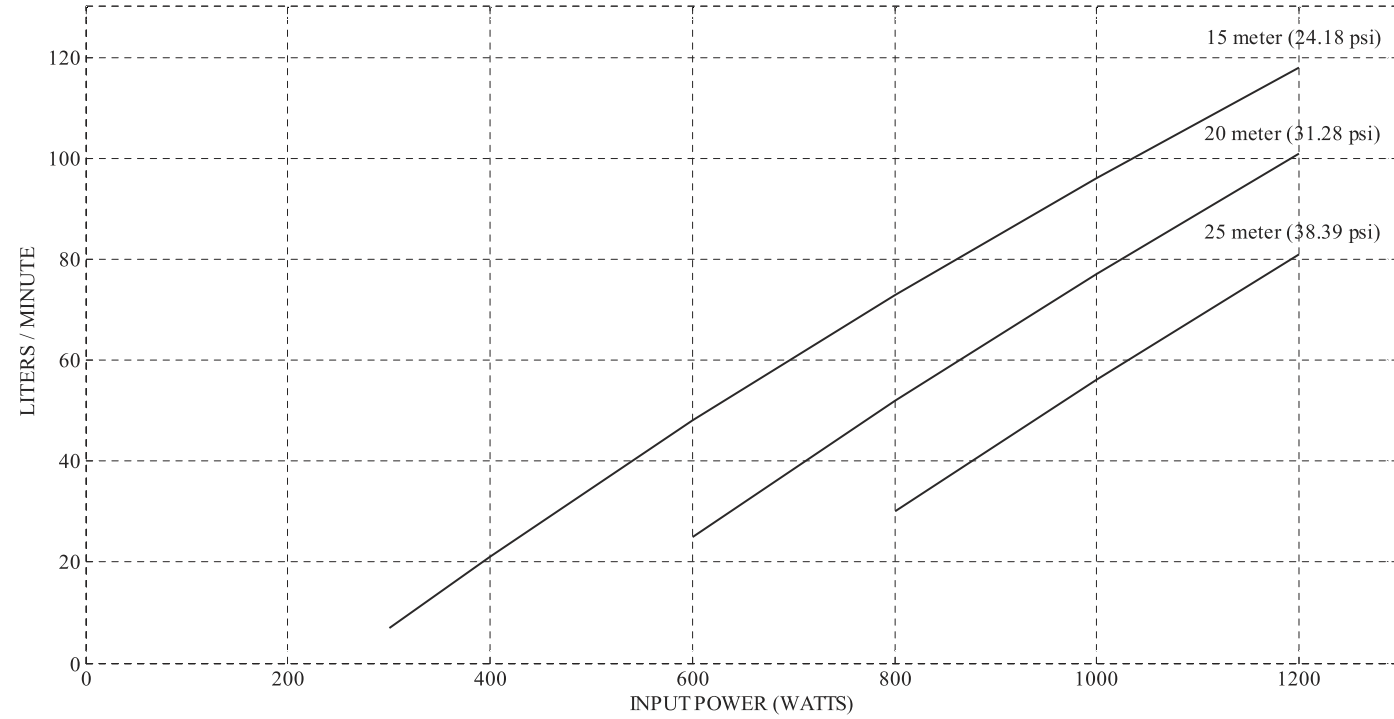

	INPUT POWER (WATTS)				
	1200	1000	800	600	400
HEAD (M)	FLOW RATE (LITERS / MINUTE)				
15	118	96	73	48	21
20	101	77	52	25	
25	81	56	30		



**PUMP PERFORMANCE SMP2000 - 20 - 56**

**MOTOR 2 HP**

160 Volt Motor  
Material Code 9000016531

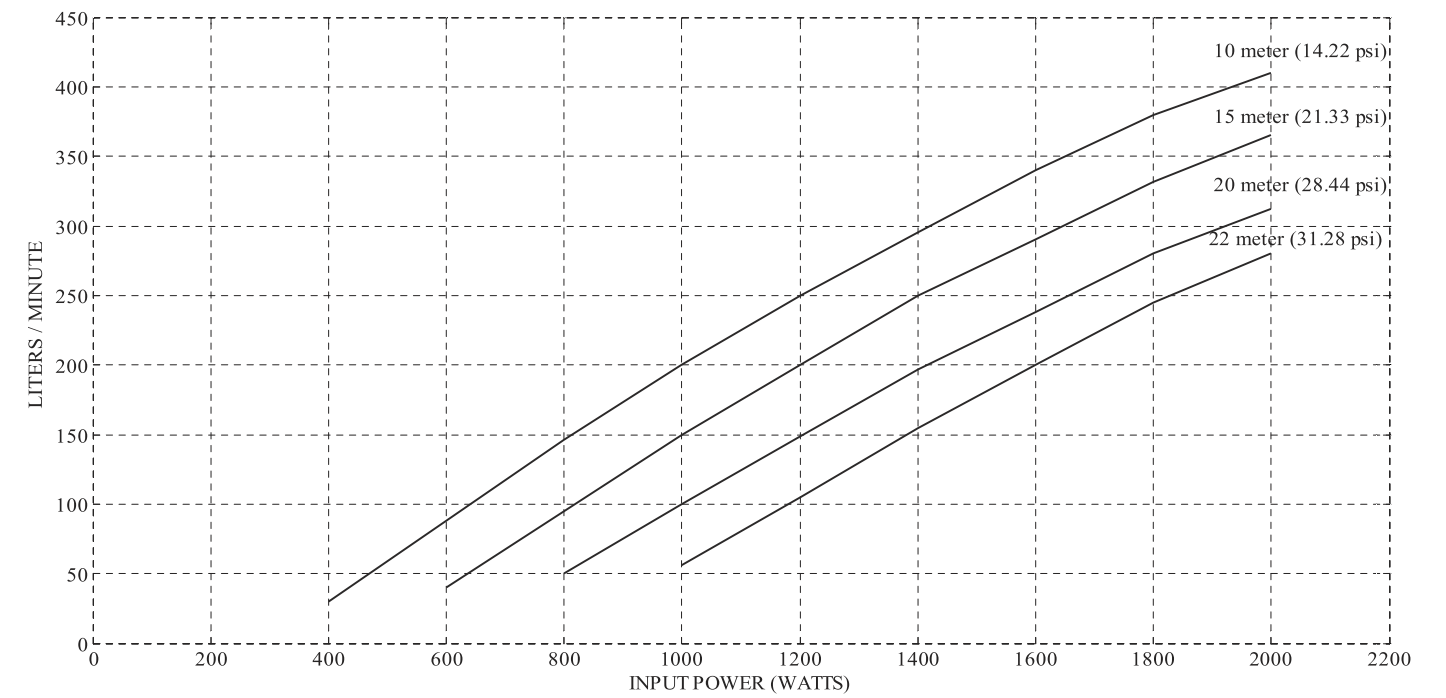

	INPUT POWER (WATTS)								
	2000	1800	1600	1400	1200	1000	800	600	400
HEAD (M)	FLOW RATE (LITERS / MINUTE)								
10	410	380	340	295	250	200	146	88	30
15	365	332	290	250	200	150	95	40	
20	312	280	238	197	149	100	50		
22	280	245	200	155	105	56			

**PUMP PERFORMANCE SMP3000 - 20 - 60**

**MOTOR 3 HP**

230 Volt Motor  
Material Code 9000018472

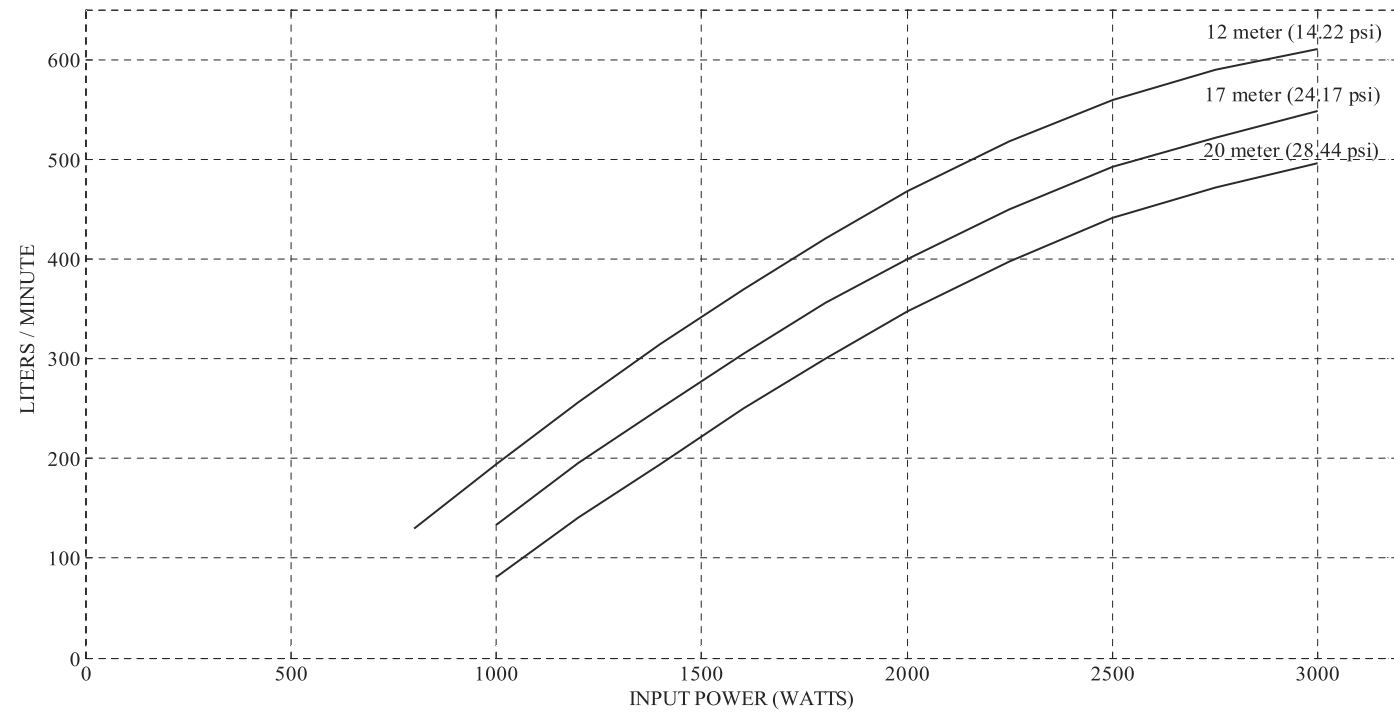

	INPUT POWER (WATTS)										
	3000	2750	2500	2250	2000	1800	1600	1400	1200	1000	800
HEAD (M)	FLOW RATE (LITRES / MINUTE)										
12	611	590	559	518	469	420	369	315	256	194	130
17	548	522	492	450	400	356	305	250	195	133	
20	496	472	441	398	348	300	250	194	140	81	



**PUMP PERFORMANCE SMP5000 - 30 - 36**

**MOTOR 5 HP**

380 Volt Motor  
Material Code 9000016533

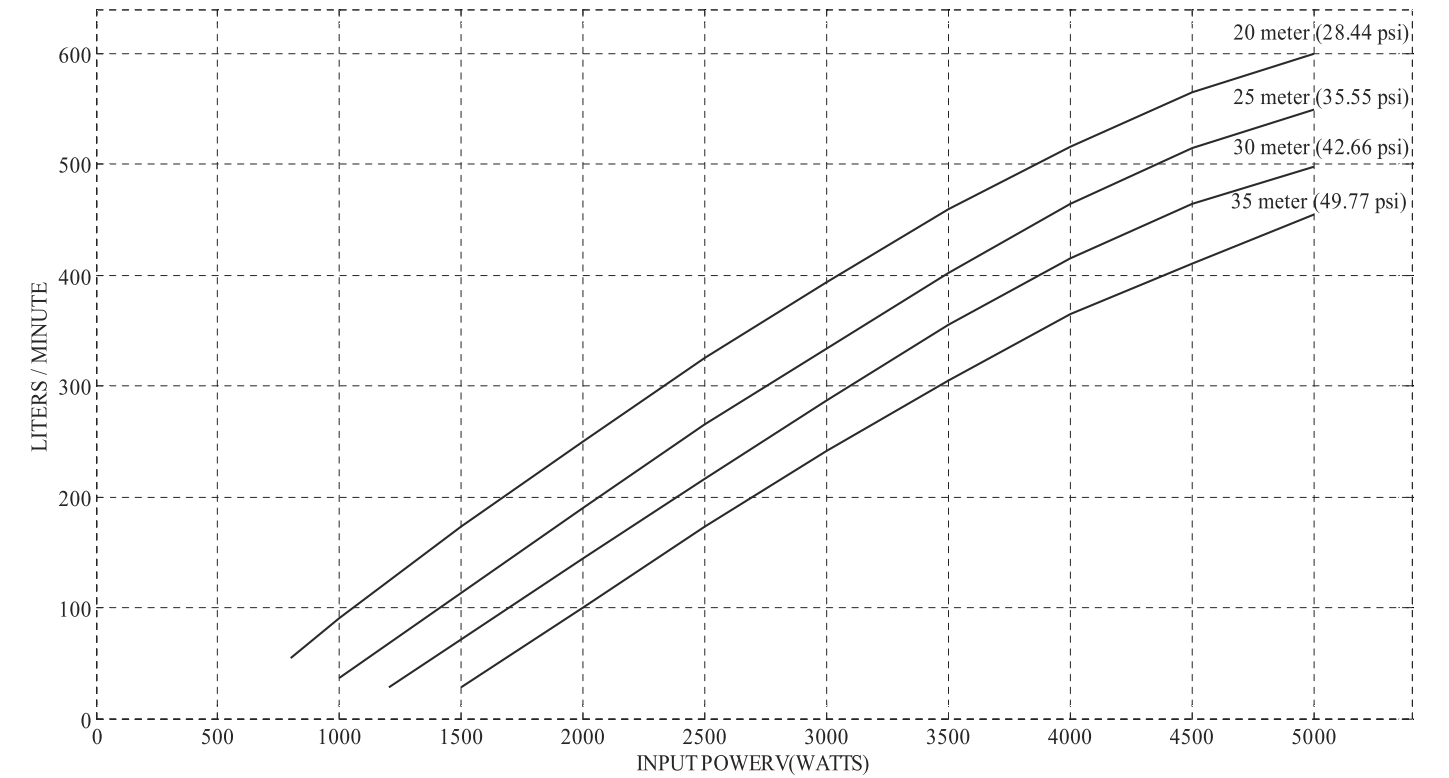

	INPUT POWER (WATTS)									
	5000	4500	4000	3500	3000	2500	2000	1500	1000	800
HEAD (M)	FLOW RATE (LITERS / MINUTE)									
20	600	565	516	460	394	325	250	173	90	54
25	550	515	465	402	334	266	190	113	37	
30	498	465	415	355	287	216	144	71		
35	455	410	365	305	242	173	100	28		